

Résultats du Championnat FSUB
de Judo Individuel
Salle de l'UMONS
Mercredi 7 décembre 2022



FSUB Judo Championship 07/12/2022 D-57

Competitors: 3

Competitors

#	Name	Club	1	2	3	Wins	Pts	Pos
1	MARIE OSTER (?) UMONS Dragons - Université de			0	10	1	10	2
2	CHLOÉ BIERNAUX (?) UMONS Dragons - Université de		10		10	2	20	1
3	ORIANE DATH (?) UCLouvain Wolves - Université		0	0		0	0	3

Matches

Match	White			Blue	Result	Time
1	MARIE OSTER	1	2	CHLOÉ BIERNAUX	0 - 10	1:30
2	MARIE OSTER	1	3	ORIANE DATH	10 - 0	3:15
3	CHLOÉ BIERNAUX	2	3	ORIANE DATH	10 - 0	0:06

Results

Pos	Name
1	CHLOÉ BIERNAUX UMONS Dragons - Université de
2	MARIE OSTER UMONS Dragons - Université de
3	ORIANE DATH UCLouvain Wolves - Université

B.U.S.F. - F.S.U.B.



FSUB Judo Championship 07/12/2022 D-63

Competitors: 3

Competitors

#	Name	Club	1	2	3	Wins	Pts	Pos
1	CELIA JAMAR (?) ULiège (Liège) - Université de			0	10	1	10	2
2	EVA NAGY (?) HELMo - Haute Ecole Libre Mosa		10		10	2	20	1
3	ENORA DEMOULIN (?) UCLouvain Wolves - Université		0	0		0	0	3

Matches

Match	White			Blue	Result	Time
1	CELIA JAMAR	1	2	EVA NAGY	0 - 10	2:39
2	CELIA JAMAR	1	3	ENORA DEMOULIN	10 - 0	1:04
3	EVA NAGY	2	3	ENORA DEMOULIN	10 - 0	0:47

Results

Pos	Name
1	EVA NAGY HELMo - Haute Ecole Libre Mosa
2	CELIA JAMAR ULiège (Liège) - Université de
3	ENORA DEMOULIN UCLouvain Wolves - Université

B.U.S.F. - F.S.U.B.



FSUB Judo Championship 07/12/2022 D-70

B.U.S.F. - F.S.U.B.



Competitors: 7

1. TINE VAN DEN BERGH (?)

Universiteit Gent

5. LARISSA BULTENA (?)

Universiteit Antwerpen

3. CAMILLIA LASAGNI (?)

KU Leuven

7. LEYLA KLUCKERS (?)

HELMo - Haute Ecole Libre Mosa

2. PAULINE GRATIA (?)

UMONS Dragons - Université de

6. IRINA WILS (?)

KU Leuven

4. MARIE BRICHAU (?)

UCLouvain Wolves - Université

8.

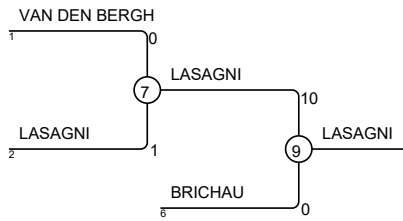

5 KLUCKERS

2 KLUCKERS

10

11 KLUCKERS

3 WILS

10

6 WILS

0

4 BRICHAU

0

3 GRATIA

8 GRATIA

0

4

10 BULTENA

5

10

Results

Pos	Name
1	LEYLA KLUCKERS HELMo - Haute Ecole Libre Mos
2	IRINA WILS KU Leuven
3	CAMILLIA LASAGNI KU Leuven
3	LARISSA BULTENA Universiteit Antwerpen
5	MARIE BRICHAU UCLouvain Wolves - Université
5	PAULINE GRATIA UMONS Dragons - Université de
7	TINE VAN DEN BERGH Universiteit Gent
7	

FSUB Judo Championship 07/12/2022 D-78

Competitors: 2

Competitors

#	Name	Club	1	2	1	2	1	2	Wins	Pts	Pos
1	LUCIE HECQ	UCLouvain Wolves - Université	0		10		1		2	11	1
2	MANON BUCHALLET	UCLouvain Wolves - Université	10		0		0		1	10	2

Matches

Match	White	Blue	Result	Time
1	LUCIE HECQ	MANON BUCHALLET	0 - 10	1:44
2	LUCIE HECQ	MANON BUCHALLET	10 - 0	2:41
3	LUCIE HECQ	MANON BUCHALLET	1 - 0	4:17

Results

Pos	Name
1	LUCIE HECQ UCLouvain Wolves - Université
2	MANON BUCHALLET UCLouvain Wolves - Université

B.U.S.F. - F.S.U.B.



FSUB Judo Championship 07/12/2022 D+78

Competitors: 3

Competitors

#	Name	Club	1	2	3	Wins	Pts	Pos
1	FRAN NAESSENS (?) Hogeschool VIVES			10	10	2	20	1
2	AISSATOU SARR (?) ULiège (Liège) - Université de		0		10	1	10	2
3	MAËLYSS SCHEMAN (?) ULB Owls - Université libre de		0	0		0	0	3

Matches

Match	White			Blue	Result	Time
1	FRAN NAESSENS	1	2	AISSATOU SARR	10 - 0	1:23
2	FRAN NAESSENS	1	3	MAËLYSS SCHEMAN	10 - 0	1:15
3	AISSATOU SARR	2	3	MAËLYSS SCHEMAN	10 - 0	3:23

Results

Pos	Name
1	FRAN NAESSENS Hogeschool VIVES
2	AISSATOU SARR ULiège (Liège) - Université de
3	MAËLYSS SCHEMAN ULB Owls - Université libre de

B.U.S.F. - F.S.U.B.



FSUB Judo Championship 07/12/2022 H-60

Competitors: 9

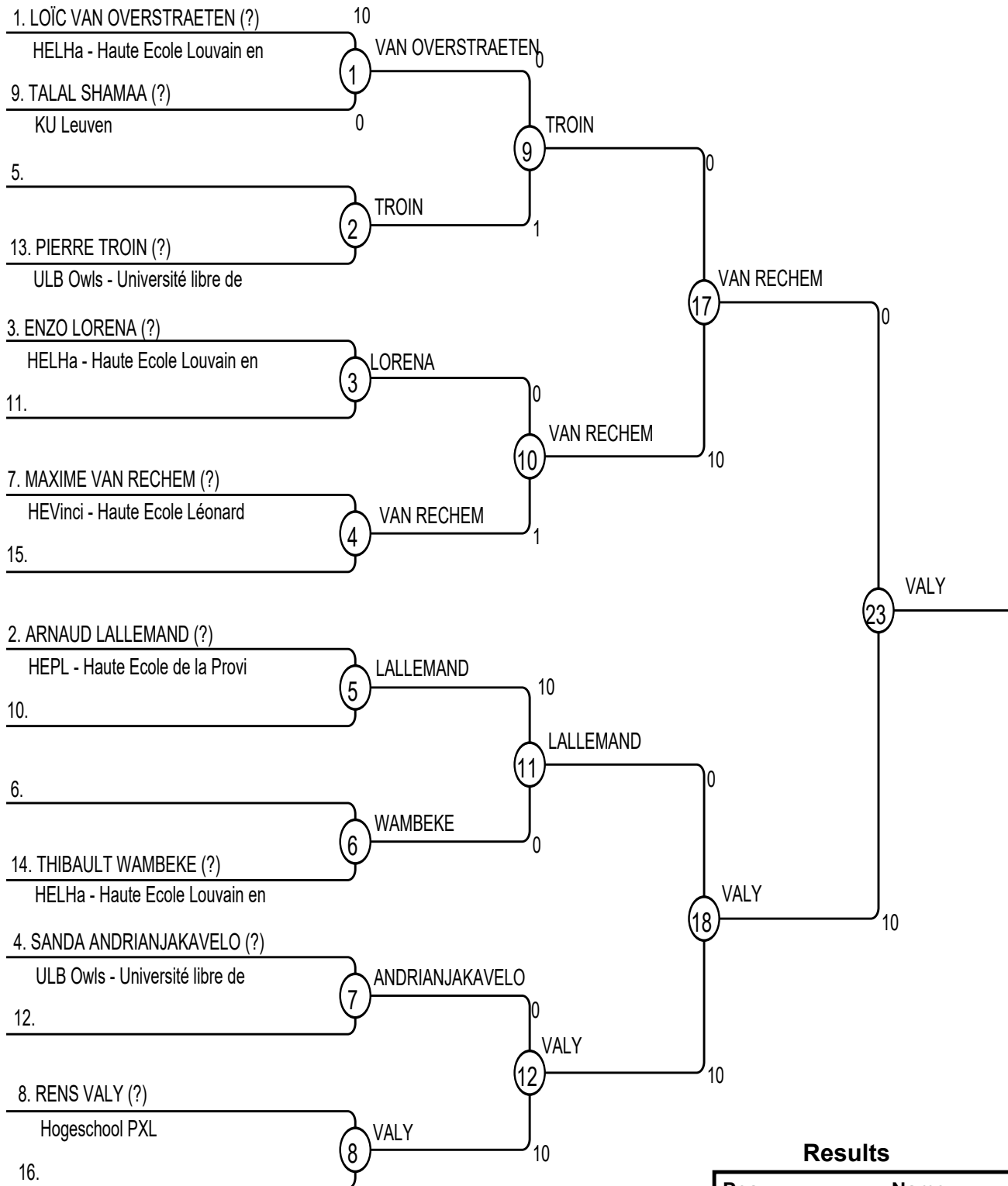

Results

Pos	Name
1	RENS VALY Hogeschool PXL
2	MAXIME VAN RECHEM HEVinci - Haute Ecole Léonard
3	ENZO LORENA HELHa - Haute Ecole Louvain en
3	PIERRE TROIN ULB Owls - Université libre de
5	ARNAUD LALLEMAND HEPL - Haute Ecole de la Province
5	THIBAUT WAMBEKE HELHa - Haute Ecole Louvain en
7	LOÏC VAN OVERSTRAETEN HELHa - Haute Ecole Louvain en
7	SANDA ANDRIANJAKAVELO ULB Owls - Université libre de

B.U.S.F. - F.S.U.B.



REPECHAGE

FSUB Judo Championship 07/12/2022 H-60

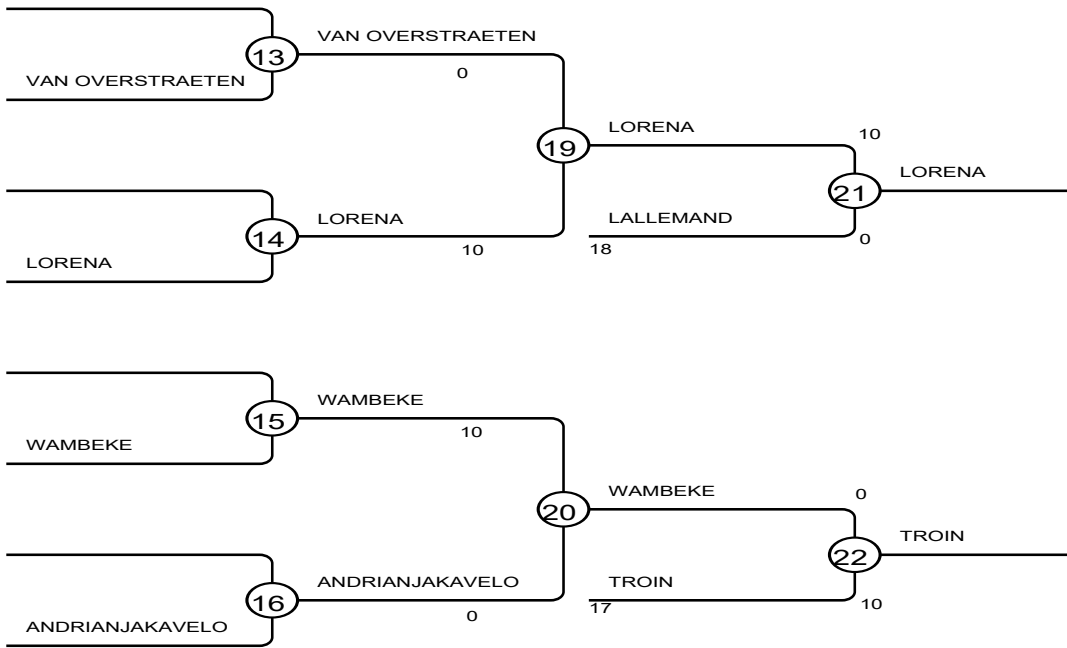

FSUB Judo Championship 07/12/2022 H-66

Competitors: 10

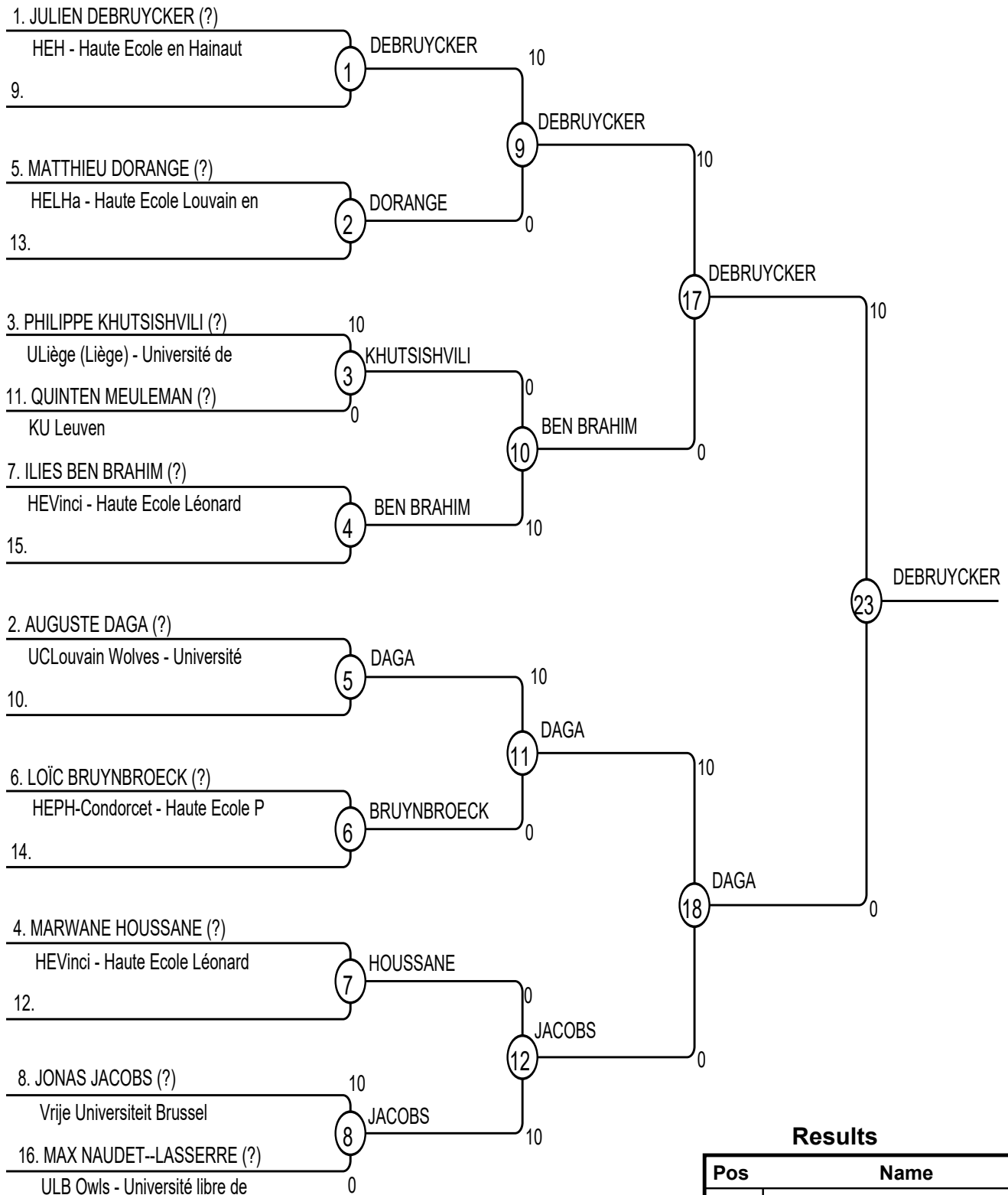

Results

Pos	Name
1	JULIEN DEBRUYCKER HEH - Haute Ecole en Hainaut
2	AUGUSTE DAGA UCLouvain Wolves - Université de Louvain
3	JONAS JACOBS Vrije Universiteit Brussel
3	ILIES BEN BRAHIM HEVinci - Haute Ecole Léonard
5	PHILIPPE KHUTSISHVILI ULiège (Liège) - Université de Liège
5	MAX NAUDET--LASSERRE ULB Owls - Université libre de Bruxelles
7	MATTHIEU DORANGE HELHa - Haute Ecole Louvain en Hainaut
7	LOÏC BRUYNBROECK HEPH-Condorcet - Haute Ecole Polytechnique de Condorcet

B.U.S.F. - F.S.U.B.



REPECHAGE

FSUB Judo Championship 07/12/2022 H-66

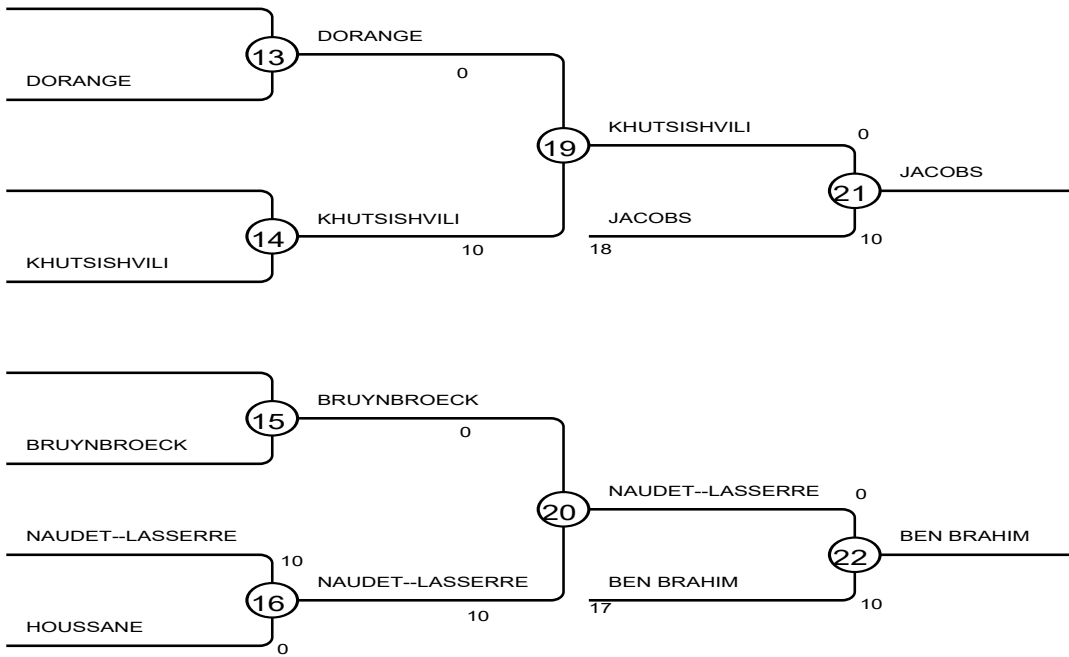

REPECHAGE

FSUB Judo Championship 07/12/2022 H-73

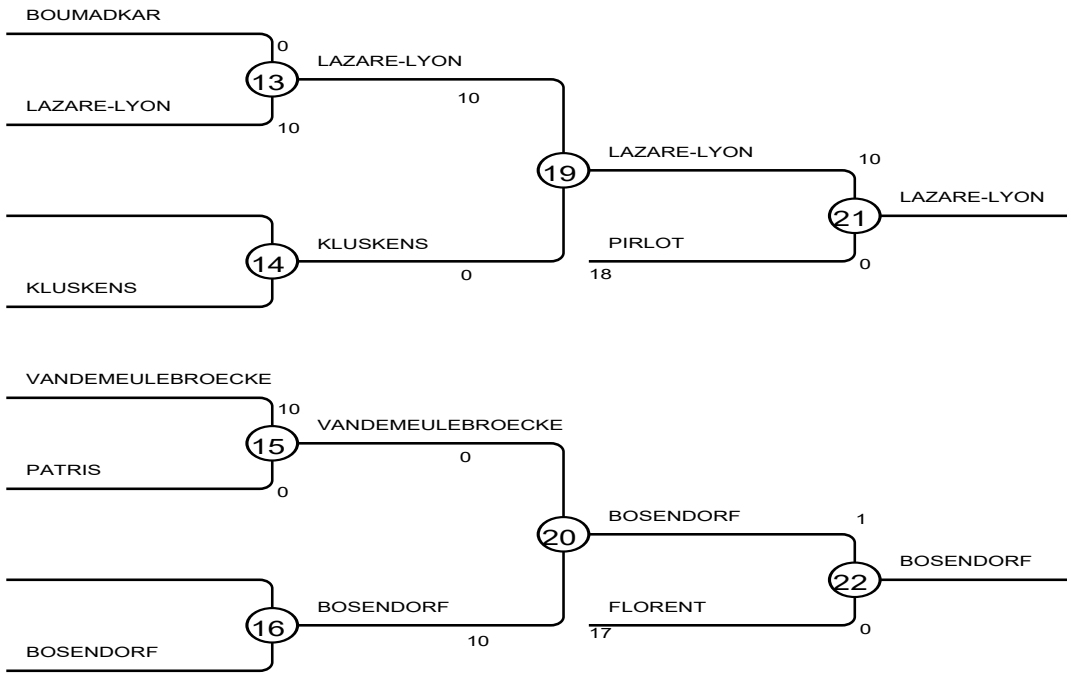

FSUB Judo Championship 07/12/2022 H-81

B.U.S.F. - F.S.U.B.



Competitors: 7

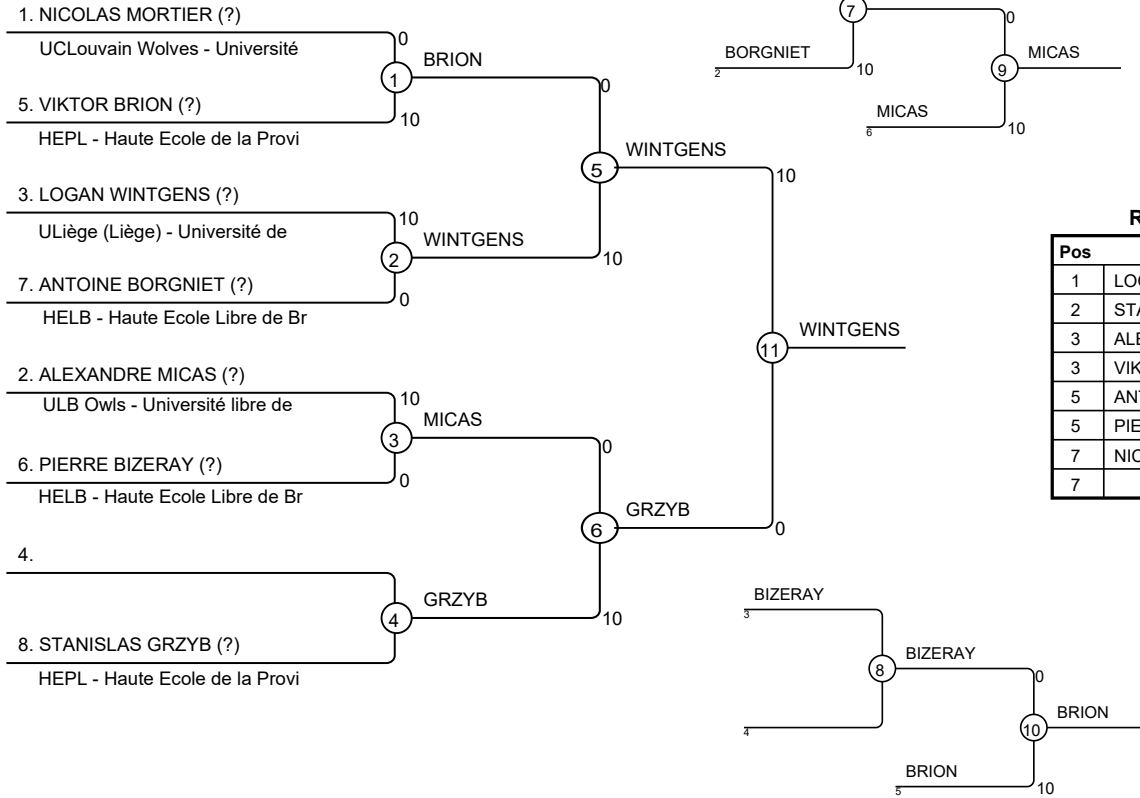

Results

Pos	Name
1	LOGAN WINTGENS ULiège (Liège) - Université de
2	STANISLAS GRZYB HEPL - Haute Ecole de la Provi
3	ALEXANDRE MICAS ULB Owls - Université libre de
3	VIKTOR BRION HEPL - Haute Ecole de la Provi
5	ANTOINE BORGNIET HELB - Haute Ecole Libre de Br
5	PIERRE BIZERAY HELB - Haute Ecole Libre de Br
7	NICOLAS MORTIER UCLouvain Wolves - Université
7	

FSUB Judo Championship 07/12/2022 H-90

Competitors: 5

Competitors

#	Name	Club	1	2	3	4	5	Wins	Pts	Pos
1	BRAM PUSSIG (?) KU Leuven			10	0	10	10	3	30	2
2	TOM VANDEPITTE (?) Hogeschool VIVES		0		0	10	0	1	10	4
3	VICTOR GOEMAN (?) KU Leuven- Technologicampus G		10	10		10	10	4	40	1
4	THIBAUT VANHEEDE (?) HELHa - Haute Ecole Louvain en		0	0	0		0	0	0	5
5	ERWAN VERSTRAETE (?) HEPL - Haute Ecole de la Provi		0	10	0	10		2	20	3

Matches

Match	White	Blue	Result	Time
1	THIBAUT VANHEEDE 4	ERWAN VERSTRAETE 5	0 - 10	1:25
2	BRAM PUSSIG 1	TOM VANDEPITTE 2	10 - 0	0:41
3	VICTOR GOEMAN 3	THIBAUT VANHEEDE 4	10 - 0	0:28
4	BRAM PUSSIG 1	ERWAN VERSTRAETE 5	10 - 0	0:42
5	TOM VANDEPITTE 2	VICTOR GOEMAN 3	0 - 10	0:26
6	BRAM PUSSIG 1	THIBAUT VANHEEDE 4	10 - 0	0:14
7	VICTOR GOEMAN 3	ERWAN VERSTRAETE 5	10 - 0	0:35
8	TOM VANDEPITTE 2	THIBAUT VANHEEDE 4	10 - 0	0:40
9	BRAM PUSSIG 1	VICTOR GOEMAN 3	0 - 10	3:04
10	TOM VANDEPITTE 2	ERWAN VERSTRAETE 5	0 - 10	3:24

Results

Pos	Name
1	VICTOR GOEMAN KU Leuven- Technologicampus G
2	BRAM PUSSIG KU Leuven
3	ERWAN VERSTRAETE HEPL - Haute Ecole de la Provi
4	TOM VANDEPITTE Hogeschool VIVES
5	THIBAUT VANHEEDE HELHa - Haute Ecole Louvain en

B.U.S.F. - F.S.U.B.



FSUB Judo Championship 07/12/2022 H-100

Competitors: 4

Competitors

#	Name	Club	1	2	3	4	Wins	Pts	Pos
1	ALEXY HALLOT (?) HELHa - Haute Ecole Louvain en			0	0	0	0	0	4
2	TENGIZ ALOUYAN (?) HELMo - Haute Ecole Libre Mosa		1		0	0	1	1	3
3	PJOTR DEBRUYNE (?) Hogeschool West-Vlaanderen		10	10		10	3	30	1
4	OLIVIER DELEFORTRIE (?) UCLouvain Wolves - Université		10	10	0		2	20	2

Matches

Match	White		Blue		Result	Time
1	ALEXY HALLOT	1	2	TENGIZ ALOUYAN	0 - 1	4:00
2	PJOTR DEBRUYNE	3	4	OLIVIER DELEFORTRIE	10 - 0	3:12
3	ALEXY HALLOT	1	3	PJOTR DEBRUYNE	0 - 10	1:06
4	TENGIZ ALOUYAN	2	4	OLIVIER DELEFORTRIE	0 - 10	1:00
5	ALEXY HALLOT	1	4	OLIVIER DELEFORTRIE	0 - 10	1:02
6	TENGIZ ALOUYAN	2	3	PJOTR DEBRUYNE	0 - 10	0:22

Results

Pos	Name
1	PJOTR DEBRUYNE Hogeschool West-Vlaanderen
2	OLIVIER DELEFORTRIE UCLouvain Wolves - Université
3	TENGIZ ALOUYAN HELMo - Haute Ecole Libre Mosa
4	ALEXY HALLOT HELHa - Haute Ecole Louvain en

B.U.S.F. - F.S.U.B.



FSUB Judo Championship 07/12/2022 H+100

Competitors: 5

Competitors

#	Name	Club	1	2	3	4	5	Wins	Pts	Pos
1	KAREL DEREERE (?) Hogeschool VIVES			0				0	0	5
2	STEVE MICHEL FOKAM BOPDA (?) HEPL - Haute Ecole de la Provi		10		10	0	0	0	0	3
3	BRANDON HAPPE (?) HEH - Haute Ecole en Hainaut			0		0		0	0	4
4	ERIC RAICK (?) HEPL - Haute Ecole de la Provi			1	10		0	1	1	2
5	AUDRIC SCHMITZ (?) HEPL - Haute Ecole de la Provi			10		10		2	20	1

Matches

Match	White		Blue		Result	Time
1	ERIC RAICK	4	5	AUDRIC SCHMITZ	0 - 10	3:30
2	KAREL DEREERE	1	2	STEVE MICHEL FOKAM BOPDA	0 - 10	1:59
3	BRANDON HAPPE	3	4	ERIC RAICK	0 - 10	2:21
4	KAREL DEREERE	1	5	AUDRIC SCHMITZ	-	
5	STEVE MICHEL FOKAM BOPDA	2	3	BRANDON HAPPE	10 - 0	0:31
6	KAREL DEREERE	1	4	ERIC RAICK	-	
7	BRANDON HAPPE	3	5	AUDRIC SCHMITZ	-	
8	STEVE MICHEL FOKAM BOPDA	2	4	ERIC RAICK	0 - 1	4:00
9	KAREL DEREERE	1	3	BRANDON HAPPE	-	
10	STEVE MICHEL FOKAM BOPDA	2	5	AUDRIC SCHMITZ	0 - 10	1:56

Results

Pos	Name
1	AUDRIC SCHMITZ HEPL - Haute Ecole de la Provi
2	ERIC RAICK HEPL - Haute Ecole de la Provi
3	STEVE MICHEL FOKAM BOPDA HEPL - Haute Ecole de la Provi
4	
5	

B.U.S.F. - F.S.U.B.

