

B.U.S.F. - F.S.U.B.



**RÉSULTATS SAISON SPORTIVE  
2021-2022  
UITSLAGEN**



































**ASEUS**

Association Sportive de l'Enseignement  
Universitaire et Supérieur ASBL

















**studentensport**  
Vlaanderen

## Fédération Sportive Universitaire Belge (FSUB)

2021-2022	Disciplines	Dates	Lieux 2021-22	Organisateurs 2021-22	Participants Enseignement Supérieur 2018-19	Participants Enseignement Supérieur 2019-20	Participants Enseignement Supérieur 2021-22	Institutions représentées 2018-19	Institutions représentées 2019-20	Institutions représentées 2021-22
	Athlétisme indoor	Ve 04/03/22	Topsporthal Gent		517 (départs hors relais)	586 (départs hors relais)	510	34	37	34
	Athlétisme outdoor	Di 01/05/22	ADEPS Jambes (club du SMAC)		399 (départs hors relais)	/	200 (départs hors relais)	42	/	27
	Badminton	Me 01/12/21	Blocry à Louvain-la-Neuve		51	42 + 23 équipes en double	38 + 16 équipes en double	14	16	9
	Course d'Orientation	Di 05/12/21	Forêt de Soignes - Rhodes St Genèse		12 (pas de ndls)	26	31	5	9	6
	Cross-Country	Sa 9/11/19	Parc Allard - Braine L'Alleud (club USBW)		38 (pas de ndls)	185	155	12	15	17
	Cyclisme Hommes	Ma 28/06/22	Zomergem		17	/	22	7	/	9
	Cyclisme Dames	Di 1/05/22	Sinaai		22 (pas de francophone)	/	28 (1 francophone)	14	/	14
	Echecs	Ma 22/02/22	Campus UAntwerpen		25	33	59	10	10	18
	Escalade	Lu 25/04/22	Klimzaal Bleau Gent - <b>ANNULE</b>		14	/	/	7	/	/
	Escrime	Di 13/02/22	Club des 3 armes - Gembloux		90	/	79	19	/	21
	Floorball	Me 9/03/2022	Complexe sportif de l'Orneau- Gembloux		6 (8 joueurs/équipe)	3 (8 joueurs/équipe)	3 (8 joueurs/équipes)	8	3	3
	Frisbee (Ultimate)	Sa 23/04/22	KU Leuven - <b>ANNULE</b>		5 équipes (10 joueurs/équipe)	/	/	4	/	/
	Gymnastique	Lu 28/03/22	Blocry à Louvain-la-Neuve		86	/	41	16	/	7
	Judo individuel	Me 8/12/21	Université de Mons		119	78	78	25	19	21
	Judo par équipe	Me 9/03/22	KU Leuven - Heverlee		3 équipes (12 joueurs/équipe)	6 équipes (12 joueurs/équipe)	6 équipes (12 joueurs/équipes)	3	5	5
	Natation	Mer 23/03/22	Pisine du Blocry (Club du Boust)		179 (départs hors relais)	199 (départs hors relais)	108 (départs hors relais)	18	19	16



## Fédération Sportive Universitaire Belge (FSUB)

2021-2022	Disciplines	Dates	Lieux 2021-22	Organisateurs 2021-22	Participants Enseignement Supérieur 2018-19	Participants Enseignement Supérieur 2019-20	Participants Enseignement Supérieur 2021-22	Institutions représentées 2018-19	Institutions représentées 2019-20	Institutions représentées 2021-22
	Padel	Ve 22/04/22	Padel 4u2 Gentbrugge		/	/	5 équipes (double)	/	/	5
	Rugby VII- Chpt	Mer 9/03/22	VUB- Brussel		8 équipes hommes 4 équipes dames	/	4 équipes hommes 3 équipes dames	8 (hommes) 6 (dames)	/	4 (hommes) 4 (dames)
	Rugby VII- Tournoi	Je 28/10/22	Kituro Rugby Club - Schaerbeek		/	8 équipes hommes 3 équipes dames	6 équipes hommes 3 équipes dames	/	9 (hommes) 3 (dames)	6 (hommes) 3 (dames)
	Ski Slalom	Je 05/05/22	Skipiste Aspen - Antwerpen - <b>ANNULE</b>		/	/	/	/	/	/
	Squash	Mer 8/12/21	Tennis Club du Parc LLN - <b>ANNULE</b>		11	/	/	7	/	/
	Tennis de Table	Je 24/02/2022	Sporthal Arteveldehogeschool		42	41	34	17	13	12
	1/4 Triathlon	Di 15/05/22	Seneffe (club des Titans)		35	/	17	11	/	11
<b>TOTAL</b>					<b>1911</b>	<b>1271</b>	<b>1698</b>			

**Résultats du Championnat  
FSUB  
d'athlétisme indoor  
RC GENT  
Vendredi 4 mars 2022**



# 17:30

## JSM-V 60m horden 84 cm

Angel Agwazie	ODISEE	8,47
Ine Mylle	KUL	8,65
Nina Denolf	UGENT	8,9
Ilana Hanssens	UGENT	8,91
Laura Van den Brande	UGENT	8,97
Emeline Cleymans	UCLW	9,33
Soukeyna Ndiaye	UCLW	9,34
Svelte MARIEN	KUL	9,43
Sara Van Hoyweghen	UGENT	9,45
Julie Vlieghe	VIVES	9,49
Romane Bruynzeels	T10	9,54
Lola De Rijck	AP	9,6
Maud Beeckmans	UGENT	9,7
Caroline Bloch	HEPL	9,96
Camille Dubus	LAST	10,13
Violette Ackaert	ULLG	10,2
Helene Lejon	UGENT	10,31
Stien De Meyer	UGENT	10,43

# 17:30

## JSM-V verspringen

MaitÃ© Beernaert	KUL	5,82
Jitse Steenmans	KUL	5,69
Jolijn Verhaeghe	KUL	5,68
Sara Van Hoyweghen	UGENT	5,63
Emeline Cleymans	UCLW	5,51
Eve Willems	UGENT	5,5
Geraldine Dheur	UCLW	5,43
Elise Debrock	KUL	5,29
Kato De Schepper	UGENT	5,23
Sara Vanhalst	UGENT	5,18
Lotte Smets	KUL	5,17
Claire Jacobs	LAST	5,15
Jade Vandenbroucke	LAST	5,15
Caroline Vanhamme	UCLW	5,12
Bo Rens	AP	5,12
Elise Poot	UCLW	4,97
Floor Cuyvers	LAST	4,94
Anneleen Veestraeten	UH	4,9
Violette Ackaert	ULLG	4,6
Femke Van Mengsel	TM	4,45
Sarah Pape	KUL	4,2

# 17:45: JSM-M polsstokhoogspringen

Arthur Simon	UCLW	NM
Robin Henry	UCLW	NM
Loïc Spigeleer	UCLW	NM
Loïc Joannes	ULLG	NM
Robin Bodart	UCLW	5,3
Pierre Straet	UCLW	4,81
Jonas Vander Avert	AP	4,61
Baptiste Lanotte	UCLW	4,61
Pierre Stavart	LAST	4,61
Yanni Sampson	LAST	4,21
Timon Van Damme	UGENT	4,01

# 17:50

## JSM-M 60m horden 107 cm

Nolan Vancauwemberghe	UMON	8,02
Senne Segers	TM	8,12
Robin Van Damme	UGENT	8,19
Vincent Vernet	T10	8,36
Dave Wesselink	INT	8,37
Ewout Dumon	T10	8,42
Robin Goossens	UGENT	8,45
Alexandre Schyns	ULGX	8,75
Tomas De Langhe	KUL	8,78
Guillaume Nihoul	HEPL	9,01
Tom Vanmarsenille	UGENT	9,31
Ruben SerrÃ©	ODISEE	9,49
Otis Van Kerm	UCLW	9,54
Arnout Schokkaert	UGENT	DNF
Robin Henry	UCLW	DQ



18:05

JSM-V 1500m

Heleen Vermeulen	UCLE	04:39,4
Lisa Jennen	KUL	04:51,0
Noor Rumers	KUL	05:17,5
HÃ©loÃ©se NIERENBERGER	UCLW	05:18,1
Louise Helsen	UA	05:22,0

# 18:15

## JSM-M 1500m

Simon Blanckaert	VIVES	04:05,9
Thibault Lelièvre	UCLW	04:08,8
Wouter Francart	UH	04:11,6
Mathéo Lecreux	UCLW	04:14,2
Axel Draux	VINC	04:18,5
Guillaume Paulissen	UNAM	04:23,5
Rik Hattas	AP	04:25,2
Arthur Van Laer	UCLE	04:26,4
Rune Lemey	UGENT	04:29,2
Glen Van Liefferinge	LAST	04:37,6
Stijn Steyaert	ODISEE	04:57,5

# 18:15

## JSM-V Hoogspringen

Lisa Clopterop	UGENT	1,83
Laura Van den Brande	UGENT	1,8
Lola De Rijck	AP	1,74
Maud Beeckmans	UGENT	1,71
Camille Dubus	LAST	1,71
Axelle Praet	LAST	1,68
Yorunn Ligneel	KUL	1,65
Marie De Troyer	HOGE	1,6
SVENIA DE CONINCK	T10	1,6
Zita Goossens	UGENT	1,6
Nathalie Van de Vorst	UGENT	1,6
Freya Beyne	UGENT	1,6
Eline Nenin	UCLW	1,55
Lise Braux	UCLW	1,55
Emilie Pardoms	UCLW	1,5
Claire Orcel	T10	1,5

# 18:15

## JSM-M Kogelstoten 7,26 kg

Andreas De Lathauwer	ODISEE	16,54
Leander Casteels	HOGE	14,53
Lukas Bats	KUL	14,35
Matthias Nutte	UMON	13,62
Jente Hauttekeete	AHS	13,58
Robbe Cherlet	HOGE	12,42
Mattice Ameele	HOGE	11,5
Dylan Volckaert	UGENT	11,01
Jobbe Das	HOGE	10,66
Brice Orelie NGONGANG PATIO	UMON	10,62
Lukas Deroo	UGENT	10,39
Charles TOURTOIS	ULB	10,01
Weng Chon Ma	UA	9,93
Hadrien Riga	HEPL	9,31
Michiel Hagen	KUL	9,14
Victor Gossard	UCLW	9,09
Liam Sprangers	UGENT	8,65
Julien Boistel	ULB	7,33
Elias Fivez	UCLE	7,11

# 18:35

## JSM-V 60m

Elise Mehuys	T10	7,38
Rani Vincke	UGENT	7,52
Lotte Van Lent	KUL	7,58
Nora Thiry	HEPL	7,59
Angel Agwazie	ODISEE	7,62
Justine Goossens	HOGE	7,62
Libelia Vincke	HOWEST	7,86
Alexandra Bekisz	UCLW	7,87
Laures Bauwens	UGENT	7,92
Hanne Bastiaansen	LAST	7,93
Luca Heyvaert	ODISEE	7,93
Lynn Beck	KUL	7,93
Charlotte Kinable	KUL	7,96
Jana Horemans	UH	7,96
Noa Claes	UCLW	8
Jane Silverans	ODISEE	8
Clara Bruggen	ULLG	8,01
Geraldine Dheur	UCLW	8,01
Laure Van Den Abeele	UCLW	8,08
Chloé O'Shea	UCLW	8,1
Leonie Van Vynckt	UGENT	8,1
Leontine Van Hoorenweder	UGENT	8,14
Xanthe Van Driessche	AHS	8,15
Sara Roggeman	LAST	8,15
Valentine Anyanwu	LAST	8,16
Lore Deviche	LAST	8,16
Lotte Van der Vreken	UGENT	8,17
Dora De Haseleer	KUL	8,17

# 18:35

## JSM-V 60m

RomÃ©e Smars	VUB	8,17
Chloe Porton	VUB	8,18
Aurore DuchÃªne	ULB	8,19
Paulien Gielis	KUL	8,24
Fien Van Passel	UGENT	8,24
Kaat Vanderbauwhede	LAST	8,26
Zyta Becu	LAST	8,26
Mirte Monbaliu	LAST	8,29
Kato D'haeyere	LAST	8,3
Roline Tshanga Diomi	LAST	8,31
Estelle Jennes	LAST	8,31
Fenne Hoobergs	KDG	8,31
Lisa De Troyer	LAST	8,32
Annabelle Bossekota-Efole	KUL	8,33
Lotte Thomas	UGENT	8,33
Clarence Eyoe-Badiata	ULB	8,33
Erja JEROUVILLE	UCLW	8,33
Pauline Debisschop	UCLW	8,35
Marie-Jo Desplenter	LAST	8,35
Lotte Philips	KUL	8,36
Lore Van den Bremt	AHS	8,39

# 18:35

## JSM-V 60m

Clara Ruzziconi	HELM	8,45
Anke Mangelschots	LAST	8,47
Audrey Van der Haegen	UGENT	8,47
Femke Sauviller	TM	8,48
Siege Van Gelder	UA	8,5
Magaly Martins Junior	LAST	8,51
Anne Loobuyck	UGENT	8,53
Camille Urban	HEPH	8,53
Miek Lagaeyse	LAST	8,54
Emma Frans	HEPL	8,55
Saloua Hasnaoui	LAST	8,61
Emma Lengele	UCLW	8,63
Olive Awouters	UCLI	8,66
Aukje van Van Hest	TM	8,68
Josephine Vandenbussche	LAST	8,69
Doga GÃ¼ndem	KUL	8,71
Joni Vantomme	VIVES	8,74
MaÃ«va Defosse	UMON	8,74
Anne-Ramon Cole	LAST	8,77
Josephine Coudeville	VIVES	8,93
Ranya YamÃ©ogo	VUB	8,95
Marit Debeer	UGENT	8,99
ChloÃ« Lievens	UGENT	9,03
Eline Demeester	UGENT	9,19
Fien Van den Bremt	UGENT	9,2
Marine Warnon	HENA	9,23
Sarah Hermans	KUL	9,42
Charlotte Roose	UGENT	9,51
Nathalie Huynh	UCLW	9,53
Monica Penalver garcia	VINC	DNS
Alizee Morency Poilvache	ULB	DNS
Lien Torfs	KUL	DQ

# 18:50

## JSM-M Hink-stap-springen

Alexis Van ElsuwÃ©	LAST	NM
Yoann Birangou	INT	NM
Pieter-jan Van cappellen	ODISEE	NM
Kwinten Torfs	KUL	14,14
Thibaut Didden	PXL	13,46
Tommy Soumahoro	ULB	13,45
Simon Dekoninck	LAST	13,28
Brent Gayse	KUL	13,22
Emile Grandjean	UCLW	13,12
Timy Staes	LAST	12,14
Sander Thiel	HOWEST	12,03
Tibo Vande Moortele	UGENT	11,8
Pieter Rombouts	UA	11,46



# 19:05

## JSM-M 60m

Yoran Deschepper	VIVES	6,86
Stef Botte	UGENT	6,97
Théo Rositano	HEPH	6,99
Niels Kerkhofs	UH	7
Ibrahim Camara	LAST	7,03
Jaron De Vriese	LAST	7,05
Eniola Taiwo	ODISEE	7,05
Wolf Beliën	HOGE	7,06
Jan De Kinder	KUL	7,11
Hadrien Wimlot	ULB	7,13
Marko Medan	ULB	7,14
Thomas Van Herreweghe	ODISEE	7,16
Kasper Torfs	KUL	7,16
Nicolas Lœonard	VINC	7,19
Jasper Annys	VIVES	7,2
Cobe Plasschaert	UGENT	7,21
Arno Vanhamme	KUL	7,22
Killian Mersseman	LAST	7,23
Robin Goossens	UGENT	7,23
Paolo Carpenito	HE2B	7,25
Laurens Lecoq	LAST	7,25
Ilias Thienpondt	LAST	7,25
Senne Segers	TM	7,25
Benjamin Evrard	UGENT	7,26
Meindert Caudron	LAST	7,26

# 19:05

## JSM-M 60m

Dave Wesselink	INT	7,26
Floran Dehout	HELH	7,27
Dries Van Langenhove	KUL	7,28
Dries Van Schuylenbergh	UGENT	7,28
Arthur Bouchat	UCLW	7,28
Thomas Florkin	UCLW	7,29
Davide Petrella	KUL	7,31
Maarten Heylen	KUL	7,32
Jens Desmedt	KUL	7,32
Robbe Vanfleteren	UGENT	7,33
Warre De Pauw	UGENT	7,34
Samuel Heymans	EPHE	7,34
Timo De Grande	UCLE	7,34
Michaël Boa	EPHE	7,35
Pablo De Wulf	VUB	7,35
Mateo Loforte	HELM	7,38
Arne Berghmans	KUL	7,38
Melvyn Claes	UCLW	7,4
Robbert Heylen	AP	7,41
Hans Vercruyssen	UGENT	7,41
Ruben Allaert	LAST	7,43
Jean-Charles Nsangolo	ULB	7,44
Reindert Dumon	UGENT	7,46
Ward Malumgrat	KUL	7,47
Aico Van Grembergen	KUL	7,47

# 19:05

## JSM-M 60m

Zaaquib Yunus Ahmed	UGENT	7,48
Joshua Tremerie	VIVES	7,49
Lorin Speybrouck	HOGE	7,5
Arne Vanfleteren	UGENT	7,52
Tuur Van Puyvelde	KUL	7,52
Maarten Lambrechts	UA	7,53
Mike Kitambala	UGENT	7,53
Thibault Guineberteau	HE2B	7,53
Pelle Gelderblom	UGENT	7,55
Jef Misplon	UGENT	7,55
Tom Vanmarsenille	UGENT	7,57
Kylian Guldentops	UA	7,58
Thomas Van Hemelrijk	AP	7,59
Alan De Meulemeester	ODISEE	7,61
Lucas Descamps	HE2B	7,63
Sander Colpaert	AHS	7,64
Jacob Keppens	KUL	7,66
David Boda	KUL	7,67
Sasha Lespagne	LAST	7,67
Senne Van Reusel	TM	7,68
Titouan Danno	ULB	7,69
YOSHI BEVERS	UA	7,69
Jenten Goeteyn	ODISEE	7,69
Bastien Janda	UCLW	7,77
Michaël Roch	HE2B	7,83
Colin Najmaoui	ULB	7,87
Romain Ringoet	VINC	7,98
Weng Chon Ma	UA	8,06
Miel Saifullahzadeh	INT	8,13
Thierry Descamps	EPHE	8,25
Gabin N'lome-nze	HEPL	8,33
Victor Recour	HOWEST	8,7
Robbe Notebaert	ODISEE	8,98
Simon Cotton	HEI H	DNS

# 19:35

## JSM-V 800m

Nadã"ge Dom Modi	UCLW	02:10,9
Amã©lie Collin	HENA	02:13,2
Nore Vandekerckhove	AHS	02:14,6
Sofie Serrã©	KUL	02:23,1
Lisa Libberecht	LAST	02:23,5
Lotte Willems	VUB	02:26,1
Femke Ysewyn	ODISEE	02:34,9
Garance Van Oldeneel	UCLW	02:35,9
Marine Nachtergal	ULB	02:36,1
Klaudia Kurza	ULB	02:36,7
Cã©line Draux	UCLW	02:39,0
Anna Lena Mael	HOWEST	02:39,5
Amal Belbard	AHS	02:46,0
Samantha Geeroms	TM	02:50,0
Chanisse FANGUENG NOUMBIAP	UMON	03:18,7

# 19:50

## JSM-M 800m

Timon Inghelbrecht	KUL	01:51,4
Maxime Delvoie	UCLW	01:51,4
Maxime Tilman	ULLG	01:51,9
Stijn Van Nieuwenhove	HOGE	01:55,7
Emile Gesqueire	KUL	01:56,4
Julian Jacquemin	ULLG	01:56,8
Joachim Bafort	UGENT	01:57,2
Romain Poblome	UMON	01:57,2
Tijs Bruyns	KUL	01:57,5
Tom Duysinx	ULLG	01:59,2
Arthur Chretien	UCLW	01:59,2
Vanderstraeten Kenzo	VUB	01:59,3
Tomas De Langhe	KUL	01:59,4
Dimitri Bertrand	HEPL	02:00,7
Alexandre Schyns	ULGX	02:03,4
Thijs Van Renterghem	LAST	02:03,7
Gilles Antoine	EPHE	02:06,7
Nils Van de Weyer	UGENT	02:06,8
Pieter-Jan Kennes	ODISEE	02:07,8
Lukas Lamont	LAST	02:08,1
Robbe Boelaert	KUL	02:12,2
Pierre Corentin	KUL	02:15,2
Ahmed Meniaoui	ULLG	02:15,2
Robin Seiller	UCLW	02:27,0
Elias Fivez	UCLE	02:34,0
Grigorii Osipov	KUL	02:40,7
Aurélien Vandeputte	UGENT	DNF
Kilian Vandenabeele	HEPH	DNS

# 19:55

## JSM-V Hink-stap-springen

	UH	NM
Margot Delbare		
Saliyya Guisse	T10	NM
Ilona Masson	HEPL	12,6
Ine Mylle	KUL	12,28
Ines Pitchon	UCLW	12,07
Jana Horemans	UH	11,2
Fenne Hoobergs	KDG	11,07
Jolijn Verhaeghe	KUL	11,03
Marie De Lille	UGENT	10,77
Ellen Peeters	AP	10,44
Kaat Demetter	UGENT	10,02

20:00

## JSM-V polsstokhoogspringen

	VIVES	NM
Julie Vlieghe		
Dag-Ferene Van Cappellen	ODISEE	3,61
Lise Morren	KUL	3,61
Hanne De Baene	UGENT	3,51
Caroline Bloch	HEPL	3,31
Hanne Vandenbroucke	KUL	3,11
Mathilde De Meue	UCLW	3,11

20:05

JSM-V 60m finale

Elise Mehuys	T10	7,42
Rani Vincke	UGENT	7,43
Justine Goossens	HOGE	7,52
Nora Thiry	HEPL	7,54
Lotte Van Lent	KUL	7,6
Angel Agwazie	ODISEE	7,63
Libelia Vincke	HOWEST	7,84
Alexandra Bekisz	UCLW	7,88



# 20:10

## JSM-M 60m finale

Yoran Deschepper	VIVES	6,82
Stef Botte	UGENT	6,89
Niels Kerkhofs	UH	6,93
Ibrahim Camara	LAST	6,94
Eniola Taiwo	ODISEE	6,98
Wolf BeliÅ«n	HOGE	7,02
Jaron De Vriese	LAST	7,03
ThÃ©o Rositano	HEPH	7,08

# 20:15

## JSM-V 3000m

Corentine Franckart	UCLW	10:31,9
Femke Deleu	VIVES	10:40,7
Emma Boone	UGENT	10:46,0
Lili Suermondt	VINC	11:21,7
Anna Lena Mauel	HOWEST	12:21,1
Björn Awouters	LUCA	12:37,2
Nadège Dom Modi	UCLW	DNS

# 20:15

## JSM-V Kogelstoten 4kg

Estelle Jennes	LAST	DNS
Jolien Maliga Boumkwo	T10	15,13
Elena Defr�re	UGENT	14,55
Mait� Beernaert	KUL	13,1
Laura Peeters	AP	12,43
Lotte Smets	KUL	11,62
Florence Boeynaems	T10	11,27
Annelien Beelaert	UGENT	11,13
Britt Rens	KDG	10,67
Kayla Iven	VINC	10,49
Phebe Vanderstraeten	UGENT	10,27
Jolien Verstraeten	AHS	10,24
Liene Daniels	PXL	10,17
Sarah Lallemand	UCLW	10,06
Zyta Becu	LAST	9,57
Lien Rubbrecht	UGENT	9,55
Helena Oste	UGENT	9,51
Jill Gintertaelle	LAST	9,11
Freya De Winter	VUB	8,45
Violette Ackaert	ULLG	8,33
Elise Regaert	ULGX	7,93
Marine Warnon	HENA	7,76
Sarah Eeckhout	UGENT	6,32

# 20:20

## JSM-M Hoogspringen

Matthias Nutte	UMON	NM
Thomas Carmoy	T10	2,2
Bram Ghuis	HOWEST	2,17
Lars Van Looy	HOGE	2,17
Arne Min	TM	2,14
Jente Hauttekeete	AHS	2,05
Jef Vermeiren	VIVES	2,02
Audric Riga	HEPL	1,99
Victor Morabito	VINC	1,99
Mā@đ@ric Zgajewski	UCLW	1,96
Viktor Van Aerde	LAST	1,93
Brice Orelie NGONGANG PATIO	UMON	1,9
Guillaume Nihoul	HEPL	1,85
Jonathan D'hondt	UGENT	1,85
Glen Van Liefferinge	LAST	1,8
Robin Daelemans	KUL	1,8
Lucas Descamps	HE2B	1,75
Jef Mislplon	UGENT	1,75
Emilien Zgajewski	VINC	1,7

# 20:30

## JSM-M 3000m

Simon Debognies	VUB	07:55,5
Alex George	n/a	07:57,6
Sander Vercauteren	HOGE	08:22,7
Kobe Hermans	KUL	08:41,3
Lenn Teugels	UA	08:44,4
Simon Eeckhout	VUB	08:46,2
Bram Rouffa	PXL	08:54,3
Andy Keymolen	VUB	08:55,7
Wout Depotter	HOGE	08:57,3
Quinten Dewaele	HOWEST	09:18,1
Maxim De Roo	UGENT	09:25,0
Tristan Blommaert	TM	09:27,7
Arthur Van Laer	UCLE	09:28,9
Arthur Goots	UA	09:54,0
Tim Vandavelde	HOWEST	09:59,6
Loïc Parmantier	LAST	10:28,6
Florian Lecocq	HEPH	10:33,7
Philip Cortvriendt	KUL	DNF
Stijn Steyaert	ODISEE	DNS

# 21:00

## JSM-V 200m

Justine Goossens	HOGE	24,13
Alizee Morency Poilvache	ULB	24,4
Kylie Lambert	T10	24,64
Sarah-Daisy Tshiamala-Bitota	HELH	24,81
Messalina Pieroni	PXL	25,09
Lotte De Foer	UGENT	25,15
Luca Heyvaert	ODISEE	25,3
Emma Broze	VINC	25,41
Ilana Hanssens	UGENT	25,51
Libelia Vincke	HOWEST	25,61
Hanne Bastiaansen	LAST	25,66
Laure Van Den Abeele	UCLW	25,76
Claire Jacobs	LAST	25,77
Alexandra Bekisz	UCLW	25,78
Clara Bruggen	ULLG	25,95
Ines Gbedassi	UCLE	25,96
Lieselotte Van Laere	KDG	25,96
Xanthe Van Driessche	AHS	26,03
Anaë's Van Snick	ODISEE	26,09
Kato De Schepper	UGENT	26,35
Lotte Van der Vreken	UGENT	26,39

# 21:00

## JSM-V 200m

Caroline Vanhamme	UCLW	26,5
ChloÃ© O'Shea	UCLW	26,68
Valentine Anyanwu	LAST	26,73
Leontine Van Hoorenweder	UGENT	26,84
Rebecca Caccamo	ULB	26,85
Paulien Gielis	KUL	26,89
Lore Deviche	LAST	26,92
Chloe Porton	VUB	26,96
Dora De Haseleer	KUL	26,97
Lisa De Troyer	LAST	26,99
Clarence Eyoe-Badiata	ULB	27,02
Charlotte Kinable	KUL	27,04
Mirte Monbaliu	LAST	27,18
Kaat Vanderbauwhede	LAST	27,28
Zyta Becu	LAST	27,33
Fien Van Passel	UGENT	27,37
Emma Frans	HEPL	27,51
Lotte Thomas	UGENT	27,53
Aurore DuchÃªne	ULB	27,59
Anke Mangelschots	LAST	27,59
Estelle Jennes	LAST	27,82
Marie-Jo Desplenter	LAST	27,84
Magaly Martins Junior	LAST	27,94
Miek Lagaeyse	LAST	28,03
Lisa Van Renterghem	HOGÉ	28,12
Lore Van den Brecht	AHS	28,14
Anneleen Veestraeten	UH	28,25
Liselotte Verhofstadt	HOWEST	28,31
Annabelle Bossekota-Efole	KUL	28,34

# 21:00

## JSM-V 200m

Audrey Van der Haegen	UGENT	28,37
Elise Poot	UCLW	28,48
Clara Ruzziconi	HELM	28,49
Anne-Ramon Cole	LAST	28,49
Saloua Hasnaoui	LAST	28,64
Anne Loobuyck	UGENT	28,75
Stien Van Loock	KUL	28,79
Hanne Vanluchene	UGENT	28,8
Margot Mortamet	UCLW	28,81
Julie Vandoorne	UGENT	28,84
Maïva Defosse	UMON	29,1
Doga Gãndem	KUL	29,25
Helene Lejon	UGENT	29,38
Josephine Vandebussche	LAST	29,4
Joni Vantomme	VIVES	29,79
Aukje van Van Hest	TM	29,9
Lisa Clopterop	UGENT	30,25
Josephine Coudeville	VIVES	30,35
Eline Demeester	UGENT	30,48
Charlotte Roose	UGENT	31,8
Nathalie Huynh	UCLW	32,08
Rani Vincke	UGENT	DNS
Roline Tshanga Diomi	LAST	DNS



# 21:00

## JSM-M Verspringen

Melvyn Claes	UCLW	NM
Kwinten Torfs	KUL	NM
Mathew Ugwu	UGENT	7,16
Yanni Sampson	LAST	7,1
Thibault Guineberteau	HE2B	6,29
Nick Boelaert	KUL	6,26
Pierre Stavart	LAST	6,21
Tijs Bruyns	KUL	6,2
Renzo Van de Vyvere	UGENT	6,16
Ramses Chekem	VUB	6,07
Senne Van Reusel	TM	5,9
Tibo Vande Moortele	UGENT	5,84
Tuur Van Puyvelde	KUL	5,83
Tom De Tollenaere	VINC	5,64
Jarne De Keyser	UGENT	5,42

# 21:30

## JSM-M 200m

Théo Rositano	HEPH	21,8
Cobe Plasschaert	UGENT	22,04
Simon Mengal	UCLW	22,06
Jaron De Vriese	LAST	22,11
Dries Van Nieuwenhove	HOGE	22,13
Jasper Annys	VIVES	22,13
Gaëtan Chiroux	VINC	22,21
Simon Mazebo	UCLW	22,22
Thomas Van Herreweghe	ODISEE	22,34
Geoffrey Jacques	HELM	22,36
Floran Dehout	HELH	22,37
Gloire Paulo Changani	HEPL	22,39
Paolo Carpenito	HE2B	22,42
Marko Medan	ULB	22,47
Benjamin Evrard	UGENT	22,48
Dries Van Langenhove	KUL	22,58
Davide Petrella	KUL	22,6
Ruben Allaert	LAST	22,68
Hadrien Piengeon	HELH	22,71
Meindert Caudron	LAST	22,74
Killian Mersseman	LAST	22,75
Warre De Pauw	UGENT	22,82
Dries Van Schuylenbergh	UGENT	22,85
Siemen Masure	UGENT	22,89
Nathan Kapenda	UCLS	23
Arthur Bouchat	UCLW	23,2
Hadrien Wimlot	ULB	23,22
Thomas Florkin	UCLW	23,26
Nils Romswinkel	UGENT	23,28
Maxime Debacker	HELH	23,3

# 21:30

## JSM-M 200m

Naam	Universiteit	Tijd
Jenten Goeteyn	ODISEE	23,3
Samuel Heymans	EPHE	23,31
Ibrahim Camara	LAST	23,43
Arne Berghmans	KUL	23,44
Ward MalumgrÃ©	KUL	23,45
Aico Van Grembergen	KUL	23,61
Joshua Tremerie	VIVES	23,75
Jean-Charles Nsangolo	ULB	23,9
Pablo De Wulf	VUB	23,97
Timo De Grande	UCLE	24,01
Maarten Lambrechts	UA	24,18
Emiel Dieussaert	UGENT	24,2
Sander Colpaert	AHS	24,29
Timy Staes	LAST	24,35
Jacob Keppens	KUL	24,57
Sasha Lespagne	LAST	24,66
Tom Kets	LAST	24,81
Bastien Janda	UCLW	24,82
Mathis Drieghe	UGENT	24,84
MichaÃ«l Roch	HE2B	25,27
Pieter Verbeke	UGENT	25,29
Colin Najmaoui	ULB	26,1
Victor Recour	HOWEST	29,53
Alan De Meulemeester	ODISEE	DNF
Jan De Kinder	KUL	DNF
Mike Kitambala	UGENT	DNS
Lorin Speybrouck	HOGE	DNS
Simon Cotton	HELH	DNS

# 21:55

## JSM-V 400m

Emma Broze	VINC	DNS
Jitse Steenmans	KUL	59,86
Emma Van Laer	UA	59,47
Ange-Victoria Callebaut	EPHE	59,18
Liefde Schoemaker	UCLW	55,68
Helena Ponette	KUL	54,46
Faustine Viart	UNAM	01:13,4
Ellen Janssens	UGENT	01:09,4
Camille Stocq	HE2B	01:08,0
Seliha Buelens	VUB	01:07,3
Olive Awouters	UCLI	01:06,6
Anke Vermaelen	KUL	01:06,4
Margot Bulsei	LAST	01:05,7
Siege Van Gelder	UA	01:05,6
Jana Milutinovic	UCLE	01:05,4
Lola Koll	LAST	01:05,0
Justine Ernst	ULLG	01:04,9
Sybil Vandamme	EPHE	01:04,9
Aude Vandenputte	LUCA	01:04,8
Morgan Laporte	KUL	01:04,7
Clarence Eyoe-Badiata	ULB	01:04,4

# 21:55

## JSM-V 400m

Marie-Lou Devillers	LAST	01:04,2
Eline Fauconnier	UCLW	01:04,0
Britt Vanherle	PXL	01:03,6
Elsa De Greef	UCLW	01:03,1
CÃ©lia Ponlot	ULLG	01:03,0
Sara Wyns	VUB	01:02,9
Jenna De Smet	UGENT	01:02,7
Lisa Geudens	AHS	01:02,6
Romee Morren	TM	01:02,4
Laureen Cugnet-Evans	UCLW	01:02,2
Timea Huyck	LAST	01:01,8
Maya Vanhee	LAST	01:01,6
Silke Daems	KDG	01:01,2
Charline LEFEVRE	ULLG	01:00,8
Alicia Colla	KUL	01:00,1

# 22:15

## JSM-M 400m

Kobe Vanhellemont	UCLE	52,99
Robbe Vanfleteren	UGENT	52,97
Gilles Vluymans	KUL	52,92
SouhaÃb Azzouz	UCLW	52,83
Romain Dumortier	ULLG	52,71
Carl Ilunga	VUB	52,42
Quentin Marlier	HEPL	52,42
Wout Van Hoof	LAST	52,41
Jasper Van Den Bulcke	UGENT	52,04
Hugues Kabuya	HEFF	51,94
Alexandre De Schryver	TM	51,87
Simon Versavel	VIVES	51,81
Victor Bettens	UGENT	51,66
Natan Decoutere	HOWEST	51,1
Charles TOURTOIS	ULB	51
Mathis Espagnet	HEPL	50,99
Robbert Heylen	AP	50,93
Simon Lavigne	HENA	50,73
Arthur Carlier	HEPH	50,54
Simone Ambrico	UH	50,47
Louie Leue	VUB	50,01
Mattis Tanghe	UGENT	49,69
Vincent Laporte	KUL	49,63
Dries Peeters	KUL	49,37
Maarten Heylen	KUL	49,37
Christian Iguacel	T10	47,66
Tibo De Smet	HOGE	47,51
Alexander Doom	AHS	46,86

# 22:15

## JSM-M 400m

Stef Botte	UGENT	01:12,3
Arthur Simon	UCLW	01:00,5
Nathan Vandamme	EPHE	59,79
Doran Platteau	UA	57,5
Jonas Huijs	INT	56,99
Jordi Verstraeten	UCLE	56,84
Ruben Hellemans	KUL	56,7
Arne Vanfleteren	UGENT	56,65
Romain Ringoet	VINC	56,56
Maarten Vermaelen	VUB	56,38
Arnaud Masschaele	HENA	55,94
Emilien Zgajewski	VINC	54,84
Pierre Laloux	UCLW	54,77
Pieterjan De Prycker	HOGE	54,75
Boris De Grelle	UCLW	54,28
David Boda	KUL	54,18
Mateo Loforte	HELM	53,63
Wouter Anckaert	LAST	53,55
Domien Godts	UA	53,51
Loïc Eertmans	UCLW	53,5
Pepijn Neuville	UGENT	53,42
Kevin Haeck	LAST	53,4
Diamory Schins	HEPL	53,34
Vincent Van Put	UA	53,31
Sarani Junior Lankiang	UGENT	53,01

# Nouveaux records Belges

## - Hommes

- o 60m horden 8"02 Nolan Vancauwemberghe Université de Mons
- o 400m 46"86 Alexander Doom Arteveldehogeschool
- o 800m 1'51"39 Timon Inghelbrecht K. Universiteit Leuven
- o 3000m 7'55"47 Simon Debognies Vrije Univ. Brussel
- o Polsstok 5m30 Robin Bodart Univ. Cat. de Louvain

## - Femmes

- o 400m 54"46 Helena Ponette K. Universiteit Leuven
- o Hinkstap 12m60 Ilona Masson HE d la Prov. de Liège
- o Hoogspringen 1m83 Zita Goossens Universiteit Gent



Résultats du Championnat FSUB  
d'Athlétisme Outdoor  
SMAC- ADEPS La Mosane à Jambes  
Dimanche 1 mai 2022



# RESULTATS COMPLETS

[F3794] - Championnats de Belgique Universitaires

SMAC | 01/05/2022



[www.lbfa.be](http://www.lbfa.be)

**Résultats : 400m Haies - TC M****Tour : \***

- **Série : 1** **OFFICIEL** (14:22:45)

Pos.	Doss.	Athlète	Cat.	Année	Cercle	Perf.	Pts	Pts. Eq.	Infos
1	1680	Peeters, Dries	SEN M	1999	AVKA-KU Leuven	<b>53.55</b>	0		
2	2881	Schyns, Alexandre	SEN M	1998	SER-OPEN	<b>55.91</b>	0		
3	2801	Lavigne, Simon	SEN M	2001	DAMP-HENAL LUX	<b>56.57</b>	0		
4	3413	Thiry, Lillian	SEN M	2002	MOHA-HEPHC	<b>1:00.72</b>	0		
5	3335	Azzouz, Souhaib	SEN M	1998	RIWA-UCLou vainW	<b>1:02.03</b>	0		
6	3194	Eertmans, Loic	SEN M	2001	CSDY-UCLou vainW	<b>1:04.86</b>	0		

**Résultats : 400m Haies - TC F****Tour : \***

- **Série : 1** **OFFICIEL** (14:18:49)

Pos.	Doss.	Athlète	Cat.	Année	Cercle	Perf.	Pts	Pts. Eq.	Infos
1	2538	Cugnet-evans, Laureen°	SEN F	2000	RCB-UCLou vainW	<b>1:05.70</b>	0		
2	2167	Welsch, Milly	SEN F	2000	SER-ULiège Lg	<b>1:07.03</b>	0		
3	2351	Fauconnier, Eline	SEN F	1999	MALM-UCLou vainW	<b>1:07.44</b>	0		
4	2361	Trussart, Véronique	SEN F	1992	DAMP-OPEN	<b>1:08.18</b>	0		
5	1314	Vermaelen, Anke	SEN F	2000	DCLA-KU Leuven	<b>1:08.45</b>	0		
	2170	Lefevre, Charline	SEN F	2002	SER-ULiège	<b>DNF</b>	0		

**Résultats : 400 mètres - TC F**

Tour : \*

- **Série : 1** **OFFICIEL** (14:58:55)

Pos.	Doss.	Athlète	Cat.	Année	Cercle	Perf.	Pts	Pts. Eq.	Infos
1	1301	Ponette, Helena	SEN F	2000	HCO-KU Leuven	52.96	1005		
2	667	Martinez, Lisa	JUN F	2003	HF-OPEN	58.18	774		
3	2144	Van den Abeele, Laure	SEN F	2000	ACLO-UCLou vainW	59.27	729		
4	1472	Wyns, Sara	SEN F	2000	VAC-VUB	59.93	702		
5	1877	Moustie, Kato	SEN F	2002	DEIN-UGENT	1:00.82	667		
6	2228	Buis, Éléa	SEN F	2001	FCHA-ULiège Lg	1:01.89	626		

- **Série : 2** **OFFICIEL** (14:58:55)

Pos.	Doss.	Athlète	Cat.	Année	Cercle	Perf.	Pts	Pts. Eq.	Infos
1	634	Ponlot, Célia	JUN F	2003	HUY-ULiège Lg	1:02.80	591		
2	585	Melin, Eva	JUN F	2004	HUY-ULiège Lg	1:03.37	570		
3	3651	Dejaie, Eve	SCO F	2005	SMAC-OPEN	1:05.25	504		
4	9944	MORTAMET, MARGOT	SEN F	2002	FRA-UCLou vainW	1:05.60	492		
5	2533	Colassin, Clemence	SEN F	2001	CSDY-UNAM UR	1:06.51	461		
6	2411	Viard, Faustine	SEN F	2002	MOHA-UNAM UR	1:13.22	263		

**Résultats : 400 mètres - TC M**Tour : \*

- **Série : 1** **OFFICIEL** (14:57:05)

Pos.	Doss.	Athlète	Cat.	Année	Cercle	Perf.	Pts	Pts. Eq.	Infos
1	658	Laurent, Luca	JUN M	2004	SMAC-OPEN	48.49	886		
2	3469	Poblome, Romain	SEN M	1998	JSMC-UMON S	50.66	784		

Pos.	Doss.	Athlète	Cat.	Année	Cercle	Perf.	Pts	Pts. Eq.	Infos
3	2842	Henry, Robin	SEN M	2001	ROCA- UCLou vainW	50.72	782		
4	2955	Schauwers, François	SEN M	1996	RFCL- ULiège Lg	52.46	705		
5	2760	Bertrand, Dimitri	SEN M	2002	SER- HEPL	52.80	690		
6	3197	Hinnekens, Simon	SEN M	1995	CSDY- UCLou vainW	53.44	663		
7	2777	Bodart, Antoine	SEN M	1996	SMAC- OPEN	53.84	646		

• **Série : 2** **OFFICIEL** (14:57:05)

Pos.	Doss.	Athlète	Cat.	Année	Cercle	Perf.	Pts	Pts. Eq.	Infos
1	1974	Boda, David	SEN M	1999	DCLA	51.76	735		
2	9948	VLUYMANS, GILLES	SEN M	1997	NA-KU Leuven	51.79	734		
3	113	Godts, Domien	JUN M	2003	BRAB- UA	53.53	659		
4	3532	Zgajewski, Emilien	SEN M	2002	ACLO- HE Vinci	53.56	658		
5	3203	Vervinckt, Maxant	SEN M	1996	SMAC- UCLou vainSL	53.70	652		
6	3409	Loforte, Matéo	SEN M	2000	SER- HELM O	53.81	647		
7	3173	Toussaint, Justin	SEN M	2002	ULA- HENAL LUX	55.02	598		

• **Série : 3** **OFFICIEL** (14:57:05)

Pos.	Doss.	Athlète	Cat.	Année	Cercle	Perf.	Pts	Pts. Eq.	Infos
1	726	Dejasse, Lois	JUN M	2004	GOSP- AP	53.34	667		
2	1635	Feyaerts, Gust	SEN M	2002	DCLA- KU Leuven	53.74	650		
3	746	De Tollenaere, Tom	JUN M	2003	RESC- HE Vinci	53.93	642		
4	2802	Azhigaliyev, Marlen	SEN M	1999	SMAC- AP	53.96	641		
5	3361	Watte, Louis	SEN M	2000	USTA- OPEN	54.14	634		
6	613	Masschaele, Arnaud	JUN M	2003	ARCH- HENAL LUX	55.54	577		

Pos.	Doss.	Athlète	Cat.	Année	Cercle	Perf.	Pts	Pts. Eq.	Infos
7	7016	Laus, Joachim	M35	1984	USTA-OPEN	55.90	563		

## Résultats : 100 mètres (séries) - TC F

### Tour : \*

- **Série : 1** **OFFICIEL** (13:38:52) Vent : -2.4 m/s

Pos.	Doss.	Athlète	Cat.	Année	Cercle	Perf.	Pts	Pts. Eq.	Infos
1	1111	Van Lent, Lotte	SEN F	2001	AVZK-KU Leuven	12.28	899		
2	2199	Bekisz, Alexandra	SEN F	2002	HF-UCLou vainW	12.74	815		
3	2275	Violle, Chloé	SEN F	2000	HERV-ULiège Lg	13.08	755		
4	713	Cochain, Laurie	JUN F	2004	GOSP-OPEN	13.12	749		
5	2202	Calujek, Ine	SEN F	2001	DAMP-HERS	13.15	743		
6	624	Buis, Noa	JUN F	2003	FCHA-ULiège Lg	13.45	693		
7	1221	Oost, Morgan	SEN F	2002	AVZK-KU Leuven	13.58	671		
	1799	Agwazie, Angel	SEN F	2001	AVLO-ODISE E	DNS	0		

- **Série : 2** **OFFICIEL** (13:38:52) Vent : -1.0 m/s

Pos.	Doss.	Athlète	Cat.	Année	Cercle	Perf.	Pts	Pts. Eq.	Infos
1	470	Bossekota-Efole, Annabelle	JUN F	2004	RAM-KU Leuven	13.23	730		
2	796	Rans, Alexane	JUN F	2004	HERV-OPEN	13.37	706		
3	340	Marien, Svelte	JUN F	2003	LYRA-KU Leuven	13.46	691		
4	2417	Penalver Garcia, Monica	SEN F	1999	RCAS-HE Vinci	13.49	686		
5	2596	Debisschop, Pauline	SEN F	2000	ATH-UCLou vainW	13.64	661		
6	580	Dehayes, Nina	JUN F	2004	HF-OPEN	13.93	615		

Pos.	Doss.	Athlète	Cat.	Année	Cercle	Perf.	Pts	Pts. Eq.	Infos
7	2580	Huynh, Nathalie	SEN F	2001	RCB- UCLou vainSL	15.44	398		

## Résultats : 100 mètres (séries) - TC M

### Tour : \*

- **Série : 1** **OFFICIEL** (14:09:46) Vent : +1.4 m/s

Pos.	Doss.	Athlète	Cat.	Année	Cercle	Perf.	Pts	Pts. Eq.	Infos
1	2969	Rocour, François	SEN M	1996	RFCL- OPEN	10.73	922		
2	3333	Motieh, Cédric	SCO M	2005	RFCL- OPEN	10.73	922		
3	3266	Rositano, Theo	SEN M	1999	CABW- HEPHC	10.90	883		
4	3277	Lo Bianco, Joshua	SCO M	2005	RFCL- OPEN	10.96	870		
5	3142	Carpenito, Paolo	SEN M	1999	RCB- HE2B	11.06	847		
6	3322	Wimlot, Hadrien	SEN M	1998	ACLO- ULB OWLS	11.15	827		
7	3187	Ghislain, Sébastien	SEN M	2000	SMAC- HENAL LUX	11.17	823		
8	3492	Okeowo, Peredjo	SEN M	1999	RESC- AP	11.23	810		

- **Série : 2** **OFFICIEL** (14:09:46) Vent : +2.3 m/s

Pos.	Doss.	Athlète	Cat.	Année	Cercle	Perf.	Pts	Pts. Eq.	Infos
1	3265	Dehout, Floran	SEN M	2001	CABW- HELHA	11.04	852		
2	647	Abdoul Wahab, Mimoun	JUN M	2004	HF- OPEN	11.17	823		
3	3267	Léonard, Nicolas	SEN M	1999	BBS- HE Vinci	11.18	821		
4	3149	Cotton, Simon	SEN M	2001	ACLO- HELHA	11.23	810		
5	3260	Atsakena Nkono, Edgard	SCO M	2005	USTA- AP	11.26	804		
6	3365	Debacker, Maxime	SEN M	2001	OSGA- HELHA	11.27	801		
7	9915	PIERLOT, RYAN	SEN M	2001	NA- ULiège Lg	12.13	626		

- **Série : 3** **OFFICIEL** (14:09:46) Vent : +1.1 m/s

Pos.	Doss.	Athlète	Cat.	Année	Cercle	Perf.	Pts	Pts. Eq.	Infos
------	-------	---------	------	-------	--------	-------	-----	----------	-------

1	3237	Morabito, Victor	SEN M	2002	RCAS-HE Vinci	11.06	847		
2	3446	Kapenda, Nathan	SEN M	1998	SMAC- UCLou vainSL	11.27	801		
3	3449	Bouchat, Arthur	SEN M	2002	SMAC- UCLou vainW	11.32	791		
4	3409	Loforte, Matéo	SEN M	2000	SER- HELM O	11.44	765		
5	172	De Kuyper, Arno	JUN M	2003	DCLA- KU Leuven	11.55	742		
6	3128	Tourtois, Charles°	SEN M	2001	RESC- ULB OWLS	11.67	717		
7	9950	GARCIA, CHARLI	SEN M	2001	NA- UCLou vainW	11.81	689		

• **Série : 4****OFFICIEL** (14:09:46) Vent : +1.1 m/s

Pos.	Doss.	Athlète	Cat.	Année	Cercle	Perf.	Pts	Pts. Eq.	Infos
1	3472	Ngongang Patio, Brice Orélien°	SEN M	1991	RCB- UMON S	11.70	711		
2	3118	Claes, Melvyn	SEN M	2001	USTA- UCLou vainW	11.74	703		
3	2964	Jockin, Nicolas	SEN M	1999	RFCL- HELM O	11.75	701		
4	2614	Mayango, Richard°	SEN M	1995	DCLA- THMO	11.76	699		
5	3091	Jonlet, Corentin	SEN M	1992	RFCL- OPEN	11.84	683		
6	2916	Moors, Mathias	SEN M	2001	HERV- ULiège Lg	12.08	635		
	669	Antonutti, Adrien	JUN M	2003	SMAC- UCLou vainW	DNS	0		

• **Série : 5****OFFICIEL** (14:09:46) Vent : +2.0 m/s

Pos.	Doss.	Athlète	Cat.	Année	Cercle	Perf.	Pts	Pts. Eq.	Infos
1	9928	OUM, CEDRIC	SEN M	2000	NA- HEPHC	11.74	703		
2	9902	JANDA, BASTIEN	SEN M	2001	NA- UCLou vainW	12.04	643		





Pos.	Doss.	Athlète	Cat.	Année	Cercle	Perf.	Pts	Pts. Eq.	Infos
3	794	Danno, Titouan	JUN M	2003	RCAS- ULB OWLS	12.04	643		
4	3294	Poblome, Olivier	SEN M	1993	JSMC- OPEN	12.11	629		
5	2664	Kaute Fotso, Duval	SEN M	1999	ATLE- HELMo	12.15	622		
6	2726	Najmaoui, Colin	SEN M	2001	ARCH- ULB OWLS	12.35	584		
7	3078	Beyaert, Corentin	SEN M	2002	RESC- VUB	12.39	576		
8	9942	DELFORGE, JEROME	SEN M	1999	NA- UCLou vainW	12.61	536		

## Résultats : 800 mètres - TC F

Tour : \*

- **Série : 1** **OFFICIEL** (15:20:04)

Pos.	Doss.	Athlète	Cat.	Année	Cercle	Perf.	Pts	Pts. Eq.	Infos
1	2267	Schauwers, Manon	SEN F	1999	RFCL- ULiège Lg	2:11.43	944		
2	2163	Collin, Amélie	SEN F	2001	UAC- HENAL LUX	2:14.37	902		
3	2218	Baudinet, Caroline	SEN F	1999	RFCL- HEPL	2:14.52	900		
4	2290	Joblin, Marine	SEN F	2002	RESC	2:16.33	874		
5	665	Laloux, Sophie	JUN F	2003	CSDY- UCLou vainSL	2:17.48	858		
6	2183	Bruno, Fiona	SEN F	2001	OSGA- UCLou vainW	2:18.46	845		
7	595	Troussart, Noémie	JUN F	2003	SMAC- HENAL LUX	2:21.22	807		
8	9924	MARTIN, LAURA	SEN F	2002	FRA- UCLou vainW	2:32.64	660		

## Résultats : 800 mètres - TC M

Tour : \*

- **Série : 1** **OFFICIEL** (15:22:18)

Pos.	Doss.	Athlète	Cat.	Année	Cercle	Perf.	Pts	Pts. Eq.	Infos
1	2966	Levaux, Ugo	SEN M	2001	RFCL- HEPL	1:55.25	0		

Pos.	Doss.	Athlète	Cat.	Année	Cercle	Perf.	Pts	Pts. Eq.	Infos
2	2329	Keymolen, Andy	SEN M	1995	BAV-VUB	1:55.86	0		
3	2863	Chretien, Arthur	SEN M	2000	USBW-UCLou vainW	1:57.27	0		
4	3198	Michel, Maxime	SEN M	1992	CSDY-OPEN	1:57.36	0		
5	2891	Delvoie, Basile	SEN M	2000	CSDY-UCLou vainW	1:58.72	0		
6	291	Gobert, Jan	JUN M	2003	OLSE-UA	2:01.38	0		
7	619	Lengelé, Antoine	JUN M	2003	OSGA-UMONS	2:02.03	0		
	2760	Bertrand, Dimitri	SEN M	2002	SER-HEPL	DNS	0		

• **Série : 2****OFFICIEL** (15:22:18)

Pos.	Doss.	Athlète	Cat.	Année	Cercle	Perf.	Pts	Pts. Eq.	Infos
1	3102	Vlassis, Laurent	SEN M	2002	RFCL-ULiège Lg	2:00.21	0		
2	630	Mullens, Victor	JUN M	2004	HUY-UCLou vainW	2:01.26	0		
3	3173	Toussaint, Justin	SEN M	2002	ULA-HENAL LUX	2:02.08	0		
4	2887	Léonard, Louis	SEN M	2000	CSDY-UCLou vainW	2:02.18	0		
5	3072	De Grelle, Boris	SEN M	2000	OCAN-UCLou vainW	2:02.45	0		
6	170	Vermaelen, Maarten	JUN M	2003	DCLA-VUB	2:06.09	0		
7	3249	Dingelstadt, Alexandre	SEN M	1995	RFCL-OPEN	2:23.63	0		

**Résultats : 1500 mètres - TC F****Tour : \***• **Série : 1****OFFICIEL** (16:03:39)

Pos.	Doss.	Athlète	Cat.	Année	Cercle	Perf.	Pts	Pts. Eq.	Infos
1	2256	Moulin, Marine	SEN F	2000	BBS-UCLou vainW	4:54.52	863		

Pos.	Doss.	Athlète	Cat.	Année	Cercle	Perf.	Pts	Pts. Eq.	Infos
2	2505	Franckart, Corentine	SEN F	2000	WACO- UCLou vainW	4:55.87	854		
3	596	Lombard, Maximilienne	JUN F	2003	OSGA- ULB OWLS	5:04.77	795		
4	2401	Suermondt, Lili°	SEN F	2002	CSDY- HE Vinci	5:22.51	684		
5	2106	Lechat, Elise	SEN F	2001	ACTE- ULiège Lg	5:42.70	567		

## Résultats : 1500 mètres - TC M

Tour : \*

- **Série : 1** **OFFICIEL** (16:05:43)

Pos.	Doss.	Athlète	Cat.	Année	Cercle	Perf.	Pts	Pts. Eq.	Infos
1	2743	Willocq, Florian	SEN M	1999	OSGA- HE2B	3:53.56	1001		
2	35	Borry, Thomas	JUN M	2003	SPBO- KU Leuven	4:00.42	950		
3	2972	Jacquerie, Adrien	SEN M	2002	SMAC- UNAM UR	4:01.41	943		
4	831	Lelievre, Thibault	JUN M	2003	WS- UCLou vainW	4:11.04	874		
5	2610	Hattas, Rik	SEN M	2000	BRAB- AP	4:18.00	825		
6	666	Devuyst, Julien	JUN M	2003	USBW- UCLou vainW	4:31.18	737		
7	2975	Bourez, Robin	SEN M	2001	USBW- UNAM UR	4:36.58	702		
8	3293	Duquesnoy, Briec	SEN M	1995	USTA- OPEN	5:09.58	506		

## Résultats : 100m Haies 0,838m - TC F

Tour : \*

- **Série : 1** **OFFICIEL** (17:07:15) Vent : -2.0 m/s

Pos.	Doss.	Athlète	Cat.	Année	Cercle	Perf.	Pts	Pts. Eq.	Infos
1	1799	Agwazie, Angel	SEN F	2001	AVLO- ODISE E	14.19	952		

Pos.	Doss.	Athlète	Cat.	Année	Cercle	Perf.	Pts	Pts. Eq.	Infos
2	340	Marien, Svelte	JUN F	2003	LYRA-KU Leuven	14.99	843		
3	2262	Cleymans, Emeline	SEN F	2001	SMAC-UCLou vainW	15.67	755		
4	2394	Coulon, Géraldine	SEN F	1998	CSDY-UCLou vainSL	16.49	655		
	2363	Smars, Romée	SEN F	2001	CABW-VUB	DQ	0		Sortie de couloir.

- **Série : 2** OFFICIEL (17:07:15) Vent : -1.3 m/s

Pos.	Doss.	Athlète	Cat.	Année	Cercle	Perf.	Pts	Pts. Eq.	Infos
1	747	Ackaert, Violette	JUN F	2003	HUY-ULiège Lg	16.80	619		
2	2336	Defosse, Maeva	SEN F	1998	MOHA-UMON S	17.08	587		
3	2376	Bloch, Caroline	SEN F	2002	SER-HEPL	17.38	554		
4	642	Ronveaux, Valentine	JUN F	2004	HUY-OPEN	17.39	553		
	2202	Calujek, Ine	SEN F	2001	DAMP-HERS	DNS	0		

## Résultats : 110m Haies 1,067m - TC M

### Tour : \*

- **Série : 1** OFFICIEL (17:07:57) Vent : +2.2 m/s

Pos.	Doss.	Athlète	Cat.	Année	Cercle	Perf.	Pts	Pts. Eq.	Infos
1	2074	Segers, Senne	SEN M	1995	LYRA-THMO	14.66	891		
2	2881	Schyns, Alexandre	SEN M	1998	SER-OPEN	15.64	774		
3	2865	Riga, Hadrien	SEN M	2000	HUY-HEPL	15.73	763		
4	2916	Moors, Mathias	SEN M	2001	HERV-ULiège Lg	16.14	717		
5	3365	Debacker, Maxime	SEN M	2001	OSGA-HELHA	23.28	137		

- **Série : 2** OFFICIEL (17:07:57) Vent : +2.9 m/s

Pos.	Doss.	Athlète	Cat.	Année	Cercle	Perf.	Pts	Pts. Eq.	Infos
1	653	Riga, Audric	JUN M	2003	HUY-HEPL	15.79	757		

Pos.	Doss.	Athlète	Cat.	Année	Cercle	Perf.	Pts	Pts. Eq.	Infos
2	3194	Eertmans, Loic	SEN M	2001	CSDY- UCLou vainW	16.10	722		
3	3421	Nihoul, Guillaume	SEN M	2000	CSDY- HEPL	16.19	711		
4	2844	Van Kerm, Otis	SEN M	2001	ROCA- UCLou vainW	19.13	421		

## Résultats : 200 mètres - TC F

Tour : \*

- **Série : 1** **OFFICIEL** (17:21:57) Vent : +2.0 m/s

Pos.	Doss.	Athlète	Cat.	Année	Cercle	Perf.	Pts	Pts. Eq.	Infos
1	2374	Tshiamala Bitota, Sarah-Daisy	SEN F	2000	ACLO- HELHA	24.58	926		
2	2414	Dheur, Géraldine	SEN F	2000	RCAS- UCLou vainW	24.99	888		
3	2385	Broze, Emma	SEN F	2000	RIWA- HE Vinci	25.20	869		
4	2199	Bekisz, Alexandra	SEN F	2002	HF- UCLou vainW	25.75	819		
5	2275	Violle, Chloé	SEN F	2000	HERV- ULiège Lg	26.02	795		
6	2394	Coulon, Géraldine	SEN F	1998	CSDY- UCLou vainSL	27.75	651		
	2144	Van den Abeele, Laure	SEN F	2000	ACLO- UCLou vainW	DNF	0		

- **Série : 2** **OFFICIEL** (17:21:57) Vent : -0.4 m/s

Pos.	Doss.	Athlète	Cat.	Année	Cercle	Perf.	Pts	Pts. Eq.	Infos
1	733	Vanhamme, Caroline	JUN F	2003	USTA- UCLou vainW	26.16	783		
2	713	Cochain, Laurie	JUN F	2004	GOSP- OPEN	26.69	738		
3	1583	Colla, Alicia	SEN F	2000	LOOI- KU Leuven	26.77	731		
4	2412	Eyoe-Badiata, Clarence	SEN F	1999	ACLO- ULB OWLS	27.00	712		

Pos.	Doss.	Athlète	Cat.	Année	Cercle	Perf.	Pts	Pts. Eq.	Infos
5	2404	Lallemand, Sarah	SEN F	2000	FCHA-UCLou vainW	27.00	712		
6	624	Buis, Noa	JUN F	2003	FCHA-ULiège Lg	27.25	691		
7	2369	Caccamo, Rebecca°	SEN F	2000	RCB-AP	27.76	650		

• **Série : 3** **OFFICIEL** (17:21:57) Vent : +0.6 m/s

Pos.	Doss.	Athlète	Cat.	Année	Cercle	Perf.	Pts	Pts. Eq.	Infos
1	470	Bossekota-Efole, Annabelle	JUN F	2004	RAM-KU Leuven	27.57	665		
2	2596	Debisschop, Pauline	SEN F	2000	ATH-UCLou vainW	28.47	594		
3	2266	Scheirlinckx, Chloé	SEN F	2001	RIWA-UCLou vainW	29.46	520		
4	2335	Legrand, Carolyne	SEN F	1997	GOSP-OPEN	30.03	480		
5	792	Manteau, Origane	JUN F	2003	USTA-HEPHC	30.17	470		
6	2411	Viard, Faustine	SEN F	2002	MOHA-UNAM UR	31.54	380		
7	2580	Huynh, Nathalie	SEN F	2001	RCB-UCLou vainSL	31.88	359		

## Résultats : 200 mètres - TC M

Tour : \*

• **Série : 1** **OFFICIEL** (17:26:31) Vent : +0.8 m/s

Pos.	Doss.	Athlète	Cat.	Année	Cercle	Perf.	Pts	Pts. Eq.	Infos
1	3334	Halleux, Lionel	SEN M	2000	RIWA-UCLou vainW	21.59	924		
2	3142	Carpenito, Paolo	SEN M	1999	RCB-HE2B	22.02	881		
3	3266	Rositano, Theo	SEN M	1999	CABW-HEPHC	22.06	877		
4	647	Abdoul Wahab, Mimoun	JUN M	2004	HF-OPEN	22.53	830		
5	3265	Dehout, Floran	SEN M	2001	CABW-HELHA	22.72	812		
6	3187	Ghislain, Sébastien	SEN M	2000	SMAC-HENAL LUX	23.07	779		

• **Série : 2** **OFFICIEL** (17:26:31) Vent : +0.8 m/s

Pos.	Doss.	Athlète	Cat.	Année	Cercle	Perf.	Pts	Pts. Eq.	Infos
1	2074	Segers, Senne	SEN M	1995	LYRA-THMO	<b>22.54</b>	829		
2	3149	Cotton, Simon	SEN M	2001	ACLO-HELHA	<b>22.56</b>	828		
3	3446	Kapenda, Nathan	SEN M	1998	SMAC-UCLou vainSL	<b>22.72</b>	812		
4	3449	Bouchat, Arthur	SEN M	2002	SMAC-UCLou vainW	<b>22.75</b>	809		
5	172	De Kuyper, Arno	JUN M	2003	DCLA-KU Leuven	<b>23.14</b>	772		
	3492	Okeowo, Peredjo	SEN M	1999	RESC-AP	<b>DNS</b>	0		

• **Série : 3** **OFFICIEL** (17:26:31) Vent : +0.3 m/s

Pos.	Doss.	Athlète	Cat.	Année	Cercle	Perf.	Pts	Pts. Eq.	Infos
1	3260	Atsakena Nkono, Edgard	SCO M	2005	USTA-AP	<b>23.25</b>	762		
2	2882	De Radigues, François	SEN M	2000	OCAN	<b>23.90</b>	702		
3	2836	Halut, Pierre	SEN M	2001	SMAC-HENAL LUX	<b>24.30</b>	666		
4	3294	Poblome, Olivier	SEN M	1993	JSMC-OPEN	<b>24.56</b>	644		
	3267	Léonard, Nicolas	SEN M	1999	BBS-HE Vinci	<b>DNS</b>	0		Perf. Hom. :DNS (0.0m/s)

• **Série : 4** **OFFICIEL** (17:26:31) Vent : -0.5 m/s

Pos.	Doss.	Athlète	Cat.	Année	Cercle	Perf.	Pts	Pts. Eq.	Infos
1	9902	JANDA, BASTIEN	SEN M	2001	NA-UCLou vainW	<b>24.69</b>	632		
2	9942	DELFORGE, JEROME	SEN M	1999	NA-UCLou vainW	<b>26.39</b>	494		
	2726	Najmaoui, Colin	SEN M	2001	ARCH-ULB OWLS	<b>DNS</b>	0		Perf. Hom. :DNS (-0.5m/s)
	9915	PIERLOT, RYAN	SEN M	2001	NA-ULiège Lg	<b>DNS</b>	0		Perf. Hom. :DNS (-0.5m/s)
	648	Renard, Louis	JUN M	2004	USTA-OPEN	<b>DQ</b>	0		Perf. Hom. :DQ (0.0m/s)

## Résultats : 5000 mètres - TC M - TC F

Tour : \*

- **Série : 1** **OFFICIEL** (18:24:28)

Pos.	Doss.	Athlète	Cat.	Année	Cercle	Perf.	Pts	Pts. Eq.	Infos
1	1802	Vercauteren, Sander	SEN M	1998	ACME-HOGE NT	14:14.21	0		
2	680	Oldenhove, Martin	JUN M	2003	CSDY-UCLou vainW	15:23.37	0		
3	2876	Willems, Oskar	SEN M	1999	RIWA-UCLou vainW	15:45.89	0		
4	5847	Penninckx, Koen	M40	1979	BAV-EHB	15:46.76	0		
5	2896	Houssiere, Pierre	SEN M	2002	CSDY-UCLou vainW	16:27.21	0		
6	800	Deswaef, Ghislain	JUN M	2003	CABW-HE Vinci	16:36.67	0		
7	3324	Houis, Mathéo	SEN M	2000	CSDY-UCLou vainW	16:49.99	0		
8	2974	Bourez, Nicolas	SEN M	2002	USBW-UCLou vainW	17:03.74	0		
9	286	Voet, Julie	JUN F	2003	AVR-UGENT	17:09.31	0		
10	803	Deck, Jeremie	JUN M	2003	ACLO	17:09.98	0		
11	4013	Soenen, Virginie	W35	1986	SMAC-OPEN	18:13.85	0		
12	9917	SKOPEK, JURAJ	SEN M	1999	SVK-KU Leuven	18:17.07	0		
13	2261	Cappelle, Stéphanie	SEN F	1988	SMAC-OPEN	19:21.62	0		
14	9923	SEILLER, ROBIN	SEN M	2000	NA-UCLou vainW	19:42.39	0		
	3500	Filafarro, Maoro	SEN M	1999	ACLO-OPEN	DNF	0		
	9945	LECOCQ, FLORIAN	SEN M	2000	NA-HEPHC	DNF	0		

**Résultats : 3000m Steeple 0,762m - TC F**Tour : \*

- **Série : 1** **OFFICIEL** (19:18:05)

Pos.	Doss.	Athlète	Cat.	Année	Cercle	Perf.	Pts	Pts. Eq.	Infos
1	1377	Spiessens, Jana	SEN F	2001	SPBO-THMO	13:32.18	0		



**Résultats : 3000m Steeple 0,914m - TC M****Tour : \***

- **Série : 1** **OFFICIEL** (19:30:04)

Pos.	Doss.	Athlète	Cat.	Année	Cercle	Perf.	Pts	Pts. Eq.	Infos
1	2814	Kanfoud, Lotfi	SEN M	1995	CRAC-HEPHC	10:13.90	0		
	3297	Schyns, Rémi	SEN M	1999	HERV-OPEN	DNS	0		Perf. Hom. :DNS (0.0m/s)

**Résultats : 4 x 100 mètres - TC M****Tour : \***

- **Série : 1** **OFFICIEL** (18:54:53)

Pos.	Doss.	Athlète	Cat.	Année	Cercle	Perf.	Pts	Pts. Eq.	Infos
1		UCL M 1			OCAN	47.36	0		

**Résultats : 4 x 400 mètres - TC F****Tour : \***

- **Série : 1** **OFFICIEL** (18:55:12)

Pos.	Doss.	Athlète	Cat.	Année	Cercle	Perf.	Pts	Pts. Eq.	Infos
1		UCL F			RCB-UCLou vainW	4:14.84	0		

**Résultats : 4 x 400 mètres - TC M****Tour : \***

- **Série : 1** **OFFICIEL** (18:55:43)

Pos.	Doss.	Athlète	Cat.	Année	Cercle	Perf.	Pts	Pts. Eq.	Infos
1		UCL Garçon 1			SMAC-AP	3:35.93	0		
2		UCL Garçon 2			CSDY-UCLou vainW	3:48.06	0		

**Résultats : 100 mètres D Finale****Tour : \***

- **Série : 1** **OFFICIEL** (15:28:16) **Vent : +1.4 m/s**

Pos.	Doss.	Athlète	Cat.	Année	Cercle	Perf.	Pts	Pts. Eq.	Infos
1	1111	Van Lent, Lotte	SEN F	2001	AVZK-KU Leuven	11.95	962		

Pos.	Doss.	Athlète	Cat.	Année	Cercle	Perf.	Pts	Pts. Eq.	Infos
2	2199	Bekisz, Alexandra	SEN F	2002	HF- UCLou vainW	12.54	851		
3	2202	Calujek, Ine	SEN F	2001	DAMP- HERS	12.74	815		
4	470	Bossekota-Efole, Annabelle	JUN F	2004	RAM- KU Leuven	13.06	759		
5	624	Buis, Noa	JUN F	2003	FCHA- ULiège Lg	13.16	742		
6	2417	Penalver Garcia, Monica	SEN F	1999	RCAS- HE Vinci	13.34	711		
7	340	Marien, Svelte	JUN F	2003	LYRA- KU Leuven	13.37	706		
	2275	Violle, Chloé	SEN F	2000	HERV- ULiège Lg	DNS	0		

• **Série : 2** **OFFICIEL** (15:28:16)

Pos.	Doss.	Athlète	Cat.	Année	Cercle	Perf.	Pts	Pts. Eq.	Infos
	713	Cochain, Laurie	JUN F	2004	GOSP- OPEN	DNS	0		
	796	Rans, Alexane	JUN F	2004	HERV- OPEN	DNS	0		
	580	Dehayes, Nina	JUN F	2004	HF- OPEN	DNS	0		

## Résultats : 100 mètres H Finale

### Tour : \*

• **Série : 1** **OFFICIEL** (16:05:05) Vent : +0.8 m/s

Pos.	Doss.	Athlète	Cat.	Année	Cercle	Perf.	Pts	Pts. Eq.	Infos
1	3266	Rositano, Theo	SEN M	1999	CABW- HEPHC	10.82	901		
2	3142	Carpenito, Paolo	SEN M	1999	RCB- HE2B	11.03	854		
3	3237	Morabito, Victor	SEN M	2002	RCAS- HE Vinci	11.12	834		
4	3322	Wimlot, Hadrien	SEN M	1998	ACLO- ULB OWLS	11.13	832		
5	3265	Dehout, Floran	SEN M	2001	CABW- HELHA	11.17	823		
6	3187	Ghislain, Sébastien	SEN M	2000	SMAC- HENAL LUX	11.22	812		

7	3149	Cotton, Simon	SEN M	2001	ACLO-HELHA	11.24	808		
8	3267	Léonard, Nicolas	SEN M	1999	BBS-HE Vinci	11.38	778		

• **Série : 2****OFFICIEL** (16:05:05) Vent : +0.4 m/s

Pos.	Doss.	Athlète	Cat.	Année	Cercle	Perf.	Pts	Pts. Eq.	Infos
1	3333	Motieh, Cédric	SCO M	2005	RFCL-OPEN	10.91	881		
2	3277	Lo Bianco, Joshua	SCO M	2005	RFCL-OPEN	11.10	838		
	2969	Rocour, François	SEN M	1996	RFCL-OPEN	DNS	0		
	647	Abdoul Wahab, Mimoun	JUN M	2004	HF-OPEN	DNS	0		
	3091	Jonlet, Corentin	SEN M	1992	RFCL-OPEN	DNS	0		
	3294	Poblome, Olivier	SEN M	1993	JSMC-OPEN	DNS	0		

**Résultats : Saut en hauteur - TC M****Tour : \***• **Groupe : 1****OFFICIEL** (15:12:54)

Pos.	Doss.	Athlète	Cat.	Année	Cercle	Perf.	Pts	Pts. Eq.	Infos
1	1837	Van Looy, Lars	SEN M	1999	VAC-AP	2m07	868		
2	1444	Geenens, Sten	SEN M	2002	ASVO-UGENT	2m04	840		
3	653	Riga, Audric	JUN M	2003	HUY-HEPL	1m98	785		
4	9914	CHEBBAH, BILAL	SEN M	2001	FRA-ULB OWLS	1m95	758		
5	9901	GOFFARD WINKIN, EDUARD	SEN M	1999	NA-KU Leuven	1m92	731		
6	3440	Zgajewski, Mederic	SEN M	1999	ACLO-UCLou vainW	1m89	705		
7	3421	Nihoul, Guillaume	SEN M	2000	CSDY-HEPL	1m80	627		
8	2844	Van Kerm, Otis	SEN M	2001	ROCA-UCLou vainW	1m75	585		
8	3532	Zgajewski, Emilien	SEN M	2002	ACLO-HE Vinci	1m75	585		

**Résultats : triple-saut - TC F**

Tour : \*

- Groupe : 1** **OFFICIEL** (16:02:54)

Pos.	Doss.	Athlète	Cat.	Année	Cercle	Perf.	Pts	Pts. Eq.	Infos
1	2414	Dheur, Géraldine	SEN F	2000	RCAS- UCLou vainW	11m34 +0.0m/s	0		
2	3595	Gomez-Mariné, Léa	SCO F	2005	HERV- OPEN	10m86 +1.9m/s	0		
3	1419	Hoobergs, Fenne	SEN F	2001	LOOI- KDG	10m78 - 0.5m/s	0		
3	2557	Campestre, Alice	SEN F	1996	HERV- OPEN	10m78 - 0.2m/s	0		

**Résultats : Lancer du poids 7,260kg - TC M**Tour : \*

- Groupe : 1** **OFFICIEL** (15:17:50)

Pos.	Doss.	Athlète	Cat.	Année	Cercle	Perf.	Pts	Pts. Eq.	Infos
1	3175	Nutte, Jean-Baptiste	SEN M	1998	RESC- UCLou vainW	14m62	766		
2	3012	Guillaume, Jonathan	SEN M	1992	RESC- OPEN	14m50	759		
3	3395	Quoidbach, Elias	SEN M	1996	CSF- OPEN	13m16	677		
4	3221	Nutte, Matthias	SEN M	2000	DS- UMON S	13m13	675		
5	3128	Tourtois, Charles°	SEN M	2001	RESC- ULB OWLS	11m85	597		
6	3451	Gathot, Florent	SEN M	2000	HERV- HELM O	10m71	528		

**Résultats : Saut a la perche - TC F**Tour : \*

- Groupe : 1** **OFFICIEL** (15:15:27)

Pos.	Doss.	Athlète	Cat.	Année	Cercle	Perf.	Pts	Pts. Eq.	Infos
1	1122	Hooyberghs, Fleur	SEN F	2001	ACHL-UGENT	3m80	887		
2	1652	Morren, Lise	SEN F	2000	RCT-KU Leuven	3m60	803		
3	1574	Van Cappellen, Dag-Ferene	SEN F	2000	OEH-ODISE E	3m50	761		
4	2376	Bloch, Caroline	SEN F	2002	SER-HEPL	3m30	680		
5	2396	De Meue, Mathilde	SEN F	1998	CSDY- UCLou vainW	3m00	563		
6	1620	Timmermans, Loes	SEN F	2001	RCT-KU Leuven	3m00	563		
7	421	Vanlangenaker, Charlotte	JUN F	2004	ATLA- OPEN	2m80	488		

## Résultats : triple-saut - TC M

Tour : \*

- **Groupe : 1** **OFFICIEL** (15:50:34)

Pos.	Doss.	Athlète	Cat.	Année	Cercle	Perf.	Pts	Pts. Eq.	Infos
1	3366	Kempeneers, Sacha	SEN M	2000	HERV- ULiège Lg	13m46 +0.9m/s	0		
2	706	Lecomte, Lilian	JUN M	2004	RFCL- OPEN	13m40 +0.6m/s	0		
3	2614	Mayango, Richard°	SEN M	1995	DCLA- THMO	13m13 +0.4m/s	0		
4	762	Grandjean, Emile	JUN M	2003	DAMP- UCLou vainW	13m11 - 0.6m/s	0		
5	3290	Basseg, Loïc	SEN M	2000	CSF- HE Vinci	12m86 - 2.9m/s	0		
6	681	Iker, Lucien	JUN M	2003	CABW- UCLou vainW	12m84 - 0.4m/s	0		

## Résultats : Lancer du poids 4,000kg - TC F

Tour : \*

- **Groupe : 1** **OFFICIEL** (15:44:50)

Pos.	Doss.	Athlète	Cat.	Année	Cercle	Perf.	Pts	Pts. Eq.	Infos
1	2133	Evans, Cassandre	SEN F	2001	HUY-HEPL	13m16	738		
2	2301	Iven, Kayla	SEN F	2002	RESC-HE Vinci	10m44	558		
3	1553	Naudts, Anke	SEN F	2001	VOLH-VIVES	9m96	527		
4	2404	Lallemand, Sarah	SEN F	2000	FCHA-UCLou vainW	9m93	525		
5	2402	Bodart, Ombeline	SEN F	2000	BBS-ULB OWLS	9m02	465		
6	2335	Legrand, Carolyne	SEN F	1997	GOSP-OPEN	8m36	423		
7	680	Warnon, Marine	JUN F	2003	ARCH-HENAL LUX	7m92	394		
8	1549	De Witte, Kato	SEN F	2002	VOLH-UA	7m75	383		
9	2381	Kairet, Alessia	SEN F	2002	GOSP-AP	7m75	383		

## Résultats : Saut en hauteur - TC F

Tour : \*

- Groupe : **1** **OFFICIEL** (16:44:41)



Pos.	Doss.	Athlète	Cat.	Année	Cercle	Perf.	Pts	Pts. Eq.	Infos
1	3134	Maes, Merel	SCO F	2005	ACW-AP	1m80	978		
2	1895	Vidts, Noor	SEN F	1996	VAC-KU Leuven	1m75	916		
3	1228	Van De Vorst, Nathalie	SEN F	2002	AVKA-UGENT	1m66	806		
4	2186	Nenin, Eline	SEN F	2000	SMAC-UCLou vainW	1m63	771		
5	2224	Braux, Lise	SEN F	2002	DAMP-UCLou vainW	1m60	736		
6	2444	Delacre, Florence	SEN F	2001	CSDY-UCLou vainW	1m55	678		
6	2521	Thomas, Estelle	SEN F	1998	HUY-ULiège Lg	1m55	678		
8	815	Lane, Julie	JUN F	2003	CSDY-UCLou vainW	1m45	566		
	9944	MORTAMET, MARGOT	SEN F	2002	FRA-UCLou vainW	NR	0		

## Résultats : Lancer du disque 2,000kg - TC M

Tour : \*

- **Groupe : 1** **OFFICIEL** (15:51:54)

Pos.	Doss.	Athlète	Cat.	Année	Cercle	Perf.	Pts	Pts. Eq.	Infos
1	3440	Zgajewski, Mederic	SEN M	1999	ACLO-UCLou vainW	32m44	513		
2	3451	Gathot, Florent	SEN M	2000	HERV-HELM O	28m89	443		

## Résultats : saut en longueur - TC F

Tour : \*

- **Groupe : 1** **OFFICIEL** (17:17:51)

Pos.	Doss.	Athlète	Cat.	Année	Cercle	Perf.	Pts	Pts. Eq.	Infos
1	1769	Smets, Lotte	SEN F	2002	TACT-KU Leuven	5m47 +0.1m/s	691		
2	1657	Baramoto, Anne-dominique	SEN F	2002	MAC-VUB	5m36 +1.0m/s	660		
3	733	Vanhamme, Caroline	JUN F	2003	USTA-UCLou vainW	5m25 +3.5m/s	628		Perf. Hom. :4m95 (-2.0m/s)
4	760	Gilson, Lucie	JUN F	2003	RFCL-ULiège Lg	5m13 +0.1m/s	595		
5	2262	Cleymans, Emeline	SEN F	2001	SMAC-UCLou vainW	5m13 +1.8m/s	595		
6	2603	Reip, Thelma	SEN F	2001	HF-UCLou vainW	5m08 +1.7m/s	581		
7	796	Rans, Alexane	JUN F	2004	HERV-OPEN	5m01 +2.5m/s	562		Perf. Hom. :4m81 (+0.6m/s)
8	2444	Delacre, Florence	SEN F	2001	CSDY-UCLou vainW	4m94 +3.2m/s	543		Perf. Hom. :4m77 (-0.4m/s)
9	2433	Pardoms, Emilie	SEN F	2000	CABW-UCLou vainW	4m81 - 0.2m/s	508		
10	2336	Defosse, Maeva	SEN F	1998	MOHA-UMON S	4m80 +0.3m/s	506		

## Résultats : Saut a la perche - TC M

Tour : \*

- **Groupe : 1** **OFFICIEL** (19:20:01)





Pos.	Doss.	Athlète	Cat.	Année	Cercle	Perf.	Pts	Pts. Eq.	Infos
1	3213	Bodart, Robin	SEN M	1997	BBS- UCLou vainW	5m25	988		
2	820	Straet, Pierre	JUN M	2003	HERV- UCLLe uven	5m10	941		
3	3192	Joannes, Loïc	SEN M	1994	CSDY- ULiège Lg	4m60	790		
4	265	Priem, Victor	JUN M	2004	AVR- OPEN	4m60	790		
5	2062	Vander Avert, Jonas	SEN M	2000	KAPE- AP	4m50	760		
6	2928	Lanotte, Baptiste	SEN M	1998	DAMP- UCLou vainW	4m40	731		
7	2862	Boa, Michaël	SEN M	1995	USBW- OPEN	4m20	673		
8	9931	MAXIMO, OLIVA	JUN M	2003	NA-KU Leuven	4m20	673		
9	2888	Francois, Simon	SEN M	2001	CSDY- OPEN	3m80	562		
10	409	Van Hemelryck, Simon	JUN M	2003	RCT- OPEN	3m80	562		
11	860	Arnaud, Batiste	JUN M	2003	SMAC- UCLou vainW	3m60	509		
	3228	Gobin, Guillaume	SEN M	1999	SER- ULiège Lg	NR	0		
	672	Pinte, Alexandre	JUN M	2004	SER- OPEN	NR	0		

## Résultats : Lancer du disque 1,000kg - TC F

Tour : \*

- Groupe : **1** **OFFICIEL** (17:28:41)



Pos.	Doss.	Athlète	Cat.	Année	Cercle	Perf.	Pts	Pts. Eq.	Infos
1	2314	Dodrimont, Emilie	SEN F	1999	CABW-HEPL	48m20	815		
2	1553	Naudts, Anke	SEN F	2001	VOLH-VIVES	44m30	738		
3	9947	KRUMLOVSKY, STEPHANIE	SEN F	1995	LUX-OPEN	40m36	661		
4	421	Vanlangenaker, Charlotte	JUN F	2004	ATLA-OPEN	39m75	649		
5	555	Regaert, Elise	JUN F	2003	OCAN-ULiège Gx	31m47	490		
6	2402	Bodart, Ombeline	SEN F	2000	BBS-ULB OWLS	25m10	371		
7	2381	Kairet, Alessia	SEN F	2002	GOSP-AP	21m90	312		

## Résultats : Lancer du javelot 800g - TC M

Tour : \*

- **Groupe : 1** **OFFICIEL** (18:35:02)



Pos.	Doss.	Athlète	Cat.	Année	Cercle	Perf.	Pts	Pts. Eq.	Infos
1	2842	Henry, Robin	SEN M	2001	ROCA- UCLou vainW	52m64	628		
2	880	Crepin, Yassin	JUN M	2004	HF- OPEN	46m06	531		
3	3132	Vanmarsenille, Tom	SEN M	2001	FCHA- UGENT	45m99	529		
4	746	De Tollenaere, Tom	JUN M	2003	RESC- HE Vinci	43m83	498		
5	2814	Kanfoud, Lotfi	SEN M	1995	CRAC- HEPHC	39m74	438		
6	641	Pire, Mattéo	JUN M	2004	SMAC- OPEN	38m18	416		
7	613	Masschaele, Arnaud	JUN M	2003	ARCH- HENAL LUX	37m35	404		
8	2865	Riga, Hadrien	SEN M	2000	HUY- HEPL	34m63	365		
9	643	Pire, Simon	JUN M	2004	SMAC- OPEN	32m25	331		
10	642	Pire, Romain	JUN M	2004	SMAC- OPEN	32m00	327		
11	860	Arnaud, Batiste	JUN M	2003	SMAC- UCLou vainW	29m56	293		
12	3072	De Grelle, Boris	SEN M	2000	OCAN- UCLou vainW	26m00	243		
13	2882	De Radigues, François	SEN M	2000	OCAN	18m37	140		

## Résultats : saut en longueur - TC M

### Tour : \*

- **Groupe : 1** **OFFICIEL** (18:32:07)

Pos.	Doss.	Athlète	Cat.	Année	Cercle	Perf.	Pts	Pts. Eq.	Infos
1	739	Reip, Martin	JUN M	2003	HF-HEPL	6m64 +0.2m/s	729		
2	3005	Campener, Corentin	SEN M	1990	RESC-OPEN	6m47 +0.9m/s	691		
3	2902	Reginster, Gaetan	SEN M	1999	USBW-UCLou vainW	6m28 +1.2m/s	648		
4	3118	Claes, Melvyn	SEN M	2001	USTA-UCLou vainW	6m16 +0.8m/s	621		
5	3221	Nutte, Matthias	SEN M	2000	DS-UMON S	6m15 - 0.5m/s	619		
6	9901	GOFFARD WINKIN, EDUARD	SEN M	1999	NA-KU Leuven	6m11 +0.1m/s	610		
7	2391	Colignon, Tim	SEN M	2001	VAC-ODISE E	6m07 - 0.8m/s	602		
8	745	Chekem, Ramses	JUN M	2003	RESC-VUB	6m05 - 0.5m/s	597		
9	9914	CHEBBAH, BILAL	SEN M	2001	FRA-ULB OWLS	5m84 +1.2m/s	552		
10	681	Iker, Lucien	JUN M	2003	CABW-UCLou vainW	5m82 +0.1m/s	548		
11	3472	Ngongang Patio, Brice Orélien°	SEN M	1991	RCB-UMON S	5m64 +1.1m/s	510		
12	7016	Laus, Joachim	M35	1984	USTA-OPEN	5m44 +0.3m/s	469		
13	9953	BENEDETTO, VALENTINI	SEN M	1999	ITA-ULB OWLS	5m22 - 0.9m/s	425		
	3413	Thiry, Lillian	SEN M	2002	MOHA-HEPHC	DNS	0		
	762	Grandjean, Emile	JUN M	2003	DAMP-UCLou vainW	NR	0		

## Résultats : lancer du javelot 600g - TC F

Tour : \*

- Groupe : 1

**OFFICIEL** (19:02:04)



Pos.	Doss.	Athlète	Cat.	Année	Cercle	Perf.	Pts	Pts. Eq.	Infos
1	2304	Smal, Pauline	SEN F	1998	RESC-HENAL LUX	45m25	768		
2	2133	Evans, Cassandre	SEN F	2001	HUY-HEPL	42m21	710		
3	2301	Iven, Kayla	SEN F	2002	RESC-HE Vinci	41m99	706		
4	1769	Smets, Lotte	SEN F	2002	TACT-KU Leuven	40m47	676		
5	1895	Vidts, Noor	SEN F	1996	VAC-KU Leuven	37m00	610		
6	1791	Wyns, Manon	SEN F	1999	OEH-ULB OWLS	36m00	591		
7	844	Muller, Sarah	JUN F	2004	RCAS-OPEN	31m44	504		
8	747	Ackaert, Violette	JUN F	2003	HUY-ULiège Lg	29m76	472		
9	555	Regaert, Elise	JUN F	2003	OCAN-ULiège Gx	28m85	455		

## Résultats : 4 x 100 mètres - TC M

Tour : \*

- **Série : 1** **OFFICIEL** (18:54:53)

Pos.	Doss.	Athlète	Cat.	Année	Cercle	Perf.	Pts	Pts. Eq.	Infos
1		<b>UCL M 1</b>				<b>47.36</b>	0		
	2882	De Radigues, François	SEN M	2000	OCAN				
	3072	De Grelle, Boris	SEN M	2000	OCAN				
	9902	JANDA, BASTIEN	SEN M	2001	-				
	3335	Azzouz, Souhaib	SEN M	1998	UCLou vainW NA- UCLou vainW RIWA- UCLou vainW				

## Résultats : 4 x 400 mètres - TC F

Tour : \*

- **Série : 1** **OFFICIEL** (18:55:12)

Pos.	Doss.	Athlète	Cat.	Année	Cercle	Perf.	Pts	Pts. Eq.	Infos
1		<b>UCL F</b>				<b>4:14.84</b>	0		
	2538	Cugnet-evans, Laureen°	SEN F	2000	RCB-				
	9944	MORTAMET, MARGOT	SEN F	2002	UCLou vainW				
	2256	Moulin, Marine	SEN F	2000	FRA-				
	2404	Lallemand, Sarah	SEN F	2000	UCLou vainW BBS- UCLou vainW FCHA- UCLou vainW				

## Résultats : 4 x 400 mètres - TC M

Tour : \*

- **Série : 1** **OFFICIEL** (18:55:43)

Pos.	Doss.	Athlète	Cat.	Année	Cercle	Perf.	Pts	Pts. Eq.	Infos
1		<b>UCL Garçon 1</b>				<b>3:35.93</b>	0		
	2802	Azhigaliyev, Marlen	SEN M	1999	SMAC				
	2842	Henry, Robin	SEN M	2001	-AP				
	2844	Van Kerm, Otis	SEN M	2001	ROCA				
	3194	Eertmans, Loic	SEN M	2001	- UCLou vainW ROCA - UCLou				

Pos.	Doss.	Athlète	Cat.	Année	Cercle	Perf.	Pts	Pts. Eq.	Infos
2		<b>UCL Garçon 2</b>				<b>3:48.06</b>	0		
	2887	Léonard, Louis	SEN M	2000	CSDY-				
	3324	Houis, Mathéo	SEN M	2000	UCLou				
	2896	Houssiere, Pierre	SEN M	2002	vainW				
	3528	Vancolen, Pierre	SEN M	2002	CSDY-				
					UCLou				
					vainW				
					CSDY-				
					UCLou				
					vainW				
					CSDY				



# Résultats du Championnat FSUB de Badminton

UCLouvain Wolves - Blocry

Mercredi 1 décembre 2021





# FSUB - Championnat

## SM1-2-3-4 - Groupe A

jeu. 02-12-21 11:41

BC de Marche

Badminton Tournament Planner

www.tournamentsoftware.com

	Club		1	2	3	4
1	UCLouvain Wolves - Univ	<b>Louis Lejeune [1]</b>		21-14 21-12	21-17 21-8	21-10 21-12
2	Universiteit Gent	Thomas Debaere	14-21 12-21		12-21 16-21	21-18 21-13
3	KU Leuven	Jeet Singh Bhatia	17-21 8-21	21-12 21-16		21-15 21-10
4	UCLouvain Wolves - Univ	Tom Spède	10-21 12-21	18-21 13-21	15-21 10-21	

Classement	Pts	omb	Jeux	Points
1 Louis Lejeune	6	3	6 - 0	126 - 73
2 Jeet Singh Bhatia	4	3	4 - 2	109 - 95
3 Thomas Debaere	2	3	2 - 4	96 - 115
4 Tom Spède	0	3	0 - 6	78 - 126

# FSUB - Championnat

## SM1-2-3-4 - Groupe B

jeu. 02-12-21 11:41

BC de Marche

Badminton Tournament Planner

www.tournamentsoftware.com

	Club		1	2	3	4
1	KU Leuven	Liam Bauwens [2]		24-22 21-17	21-14 10-21 21-10	21-5 21-12
2	HEFF - Haute Ecole Fran	Edouard Lardin	22-24 17-21		16-21 21-19 16-21	11-21 21-19 21-16
3	UCLouvain Wolves - Univ	Allan Chevalier	14-21 21-10 10-21	21-16 19-21 21-16		21-18 21-10
4	ULB Owls - Université lib	Benjamin Martinet	5-21 12-21	21-11 19-21 16-21	18-21 10-21	

Classement	Pts	omb	Jeux	Points
1 Liam Bauwens	6	3	6 - 1	139 - 101
2 Allan Chevalier	4	3	5 - 3	148 - 133
3 Edouard Lardin	2	3	3 - 5	145 - 162
4 Benjamin Martinet	0	3	1 - 6	101 - 137

# FSUB - Championnat

SM1-2-3-4

Date  
01 déc. 2021

Ville, Pays  
Louvain-La-Neuve, BEL

Site WEB

Printed: 02-12-21 11:41:01

	Club	Finale	Vainquer
1	Olves - Université catholique de Louvain	<b>Louis Lejeune [1]</b>	
			<b>Louis Lejeune [1]</b> 21-18 21-11
2	KU Leuven	<b>Liam Bauwens [2]</b>	

# FSUB - Championnat

SM5-6

Date  
01 déc. 2021

Ville, Pays  
Louvain-La-Neuve, BEL

Site WEB

Printed: 02-12-21 11:41:01

Club	Round 1	Round 2	Quarts de finale	Demi-finale	Finale
1	ls - Université libre de B	<b>Vincent Yang [1]</b>			
2		Bye 1	<b>Vincent Yang [1]</b>		
3	Universiteit Gent	Joachim Bonte	<b>Vincent Yang [1]</b> 24-22 21-17		
4	KU Leuven	Stefan Martens	Stefan Martens 21-15 21-15		
5	blves - Université catholique	Noé Dubois		Martin Diederich 26-24 21-16	
6		Bye 5	Noé Dubois		
7	KU Leuven	Sarvesh Jiginni	Martin Diederich 21-15 15-21 21-9		
8	ls - Université libre de B	Martin Diederich	Martin Diederich 21-16 21-18		
9	blves - Université catholique	<b>Dorian Spilette [3]</b>			Martin Diederich 21-14 19-21 21-18
10		Bye 3	<b>Dorian Spilette [3]</b>		
11	- Haute Ecole Léonard d	Jean-Benoit Fontaine	<b>Dorian Spilette [3]</b> 21-18 21-18		
12	ls - Université libre de B	Loic Smal	Loic Smal 21-11 21-16		
13	e (Liège) - Université de	Robin De Raeve		Robin De Raeve 21-16 17-21 21-14	
14		Bye 7	Robin De Raeve		
15	blves - Université catholique	Loup Struvay	Robin De Raeve 21-10 21-23 21-13		
16	KU Leuven	Jonathan Pijl	Jonathan Pijl 22-20 21-14		
17	Universiteit Gent	Simon Krols			Timmy Pham 12-21 21-18 21-19
18	blves - Université catholique	Gauthier Dutertre	Gauthier Dutertre 16-21 21-17 21-11		
19		Bye 8	Gauthier Dutertre 16-21 21-13 21-10		
20	ls - Université libre de B	Maxime Maho	Maxime Maho		
21	KU Leuven	Diede Peeters		Gauthier Dutertre 21-19 8-21 21-19	
22	Haute Ecole Libre de Br	Jules Challois	Jules Challois 21-13 21-8		
23		Bye 4	<b>Florian Peeters [4]</b> 21-15 21-14		
24	blves - Université catholique	<b>Florian Peeters [4]</b>	<b>Florian Peeters [4]</b>		
25	- Haute Ecole Léonard d	Jorge Lopez Vasquez			Timmy Pham 22-20 21-17
26	ls - Université libre de B	Timmy Pham	Timmy Pham 21-15 21-14		
27		Bye 6	Timmy Pham 21-11 21-19		
28	blves - Université catholique	Ben Struvay	Ben Struvay		
29	blves - Université catholique	Nathan Bertholet		Timmy Pham 12-21 21-18 21-15	
30	Universiteit Gent	Thomas Schaep	Thomas Schaep w.o.		
31		Bye 2	Thomas Schaep 21-19 21-18		
32	KU Leuven	<b>Niel Swinnen [2]</b>	<b>Niel Swinnen [2]</b>		

# FSUB - Championnat

## SM5-6 - CONSOLANTE

Date  
01 déc. 2021

Ville, Pays  
Louvain-La-Neuve, BEL

Site WEB

Printed: 02-12-21 11:41:01

Round 1                      Quarts de finale                      Demi-finale                      Finale                      Vainqueur



# FSUB - Championnat

## SD1-2-3-4

jeu. 02-12-21 11:41

BC de Marche

Badminton Tournament Planner

www.tournamentsoftware.com

	Club		1	2	3
1	KU Leuven	<b>Thys Silke [1]</b>	X	19-21 21-14 16-21	18-21 10-21
2	UCLouvain Wolves - Univ	<b>Rachel Delforge [2]</b>	21-19 14-21 21-16	X	18-21 18-21
3	UCLouvain Wolves - Univ	Yseult Canautte	21-18 21-10	21-18 21-18	X

Classement	Pts	omb	Jeux	Points
1 Yseult Canautte	4	2	4 - 0	84 - 64
2 Rachel Delforge	2	2	2 - 3	92 - 98
3 Thys Silke	0	2	1 - 4	84 - 98

# FSUB - Championnat

## SD5-6

jeu. 02-12-21 11:41

BC de Marche

Badminton Tournament Planner

www.tournamentsoftware.com

	Club		1	2	3	4	5
1	KU Leuven	Elke Barbier		21-10 21-5	w.o. Gagné	21-17 21-8	17-21 19-21
2	UCLouvain Wolves - Univ	Alicia Guillen Lazo	10-21 5-21		w.o. Gagné	6-21 8-21	12-21 6-21
3	KU Leuven	Catoo Van Driessche	w.o. Perdu	w.o. Perdu		w.o. Perdu	w.o. Perdu
4	Universiteit Gent	Jera Van Nieuwenhuyse	17-21 8-21	21-6 21-8	w.o. Gagné		21-17 9-21 10-21
5	Universiteit Gent	Sara Careelmont	21-17 21-19	21-12 21-6	w.o. Gagné	17-21 21-9 21-10	

Classement	Pts	omb	Jeux	Points
1 Sara Careelmont	6	3	6 - 1	143 - 94
2 Elke Barbier	4	3	4 - 2	120 - 82
3 Jera Van Nieuwenhuyse	2	3	3 - 4	107 - 115
4 Alicia Guillen Lazo	0	3	0 - 6	47 - 126
5 Catoo Van Driessche	0	0	0 - 0	0 - 0

# FSUB - Championnat

## DM1-2-3-4

jeu. 02-12-21 11:41

BC de Marche

Badminton Tournament Planner

www.tournamentsoftware.com

	Club		1	2	3	4
1	Universiteit Gent Universiteit Gent	<b>Thomas Debaere [1]</b> <b>Simon Krols</b>	X	w.o. Perdu	w.o. Perdu	12-21 11-21
2	UCLouvain Wolves - Univ UCLouvain Wolves - Univ	<b>Allan Chevalier [2]</b> <b>Dorian Spilette</b>	w.o. Gagné	X	21-10 21-11	21-10 21-13
3	KU Leuven KU Leuven	Liam Bauwens Stefan Martens	w.o. Gagné	10-21 11-21	X	7-21 12-21
4	ULB Owls - Université lib ULB Owls - Université lib	Benjamin Martinet Vincent Yang	21-12 21-11	10-21 13-21	21-7 21-12	X

Classement	Pts	omb	Jeux	Points
1 Allan Chevalier Dorian Spilette	4	2	4 - 0	84 - 44
2 Benjamin Martinet Vincent Yang	2	2	2 - 2	65 - 61
3 Liam Bauwens Stefan Martens	0	2	0 - 4	40 - 84
4 Thomas Debaere Simon Krols	0	0	0 - 0	0 - 0



# FSUB - Championnat

## DM5-6 - Groupe A

jeu. 02-12-21 11:41

BC de Marche

Badminton Tournament Planner

www.tournamentsoftware.com

	Club		1	2	3	4
1	UCLouvain Wolves - Univ ULB Owls - Université libre	<b>Florian Peeters [1]</b> <b>Timmy Pham</b>		21-11 21-16	21-17 21-12	w.o. Gagné
2	UCLouvain Wolves - Univ UCLouvain Wolves - Univ	Tom Spède Ben Struvay	11-21 16-21		20-22 21-15 19-21	w.o. Gagné
3	KU Leuven KU Leuven	Diede Peeters Niel Swinnen	17-21 12-21	22-20 15-21 21-19		w.o. Gagné
4		Bye	w.o. Perdu	w.o. Perdu	w.o. Perdu	

Classement	Pts	omb	Jeux	Points
1 Florian Peeters Timmy Pham	4	2	4 - 0	84 - 56
2 Diede Peeters Niel Swinnen	2	2	2 - 3	87 - 102
3 Tom Spède Ben Struvay	0	2	1 - 4	87 - 100
4	0	0	0 - 0	0 - 0

# FSUB - Championnat

## DM5-6 - Groupe B

jeu. 02-12-21 11:41

BC de Marche

Badminton Tournament Planner

www.tournamentsoftware.com

	Club		1	2	3	4
1	HELB - Haute Ecole Libre HEFF - Haute Ecole Fran	<b>Jules Challois [2]</b> <b>Edouard Lardin</b>		21-18 21-10	21-10 21-17	R1
2	KU Leuven KU Leuven	Jeet Singh Bhatia Sarvesh Jigjinni	18-21 10-21		21-18 21-18	R3
3	ULB Owls - Université lib ULB Owls - Université lib	Maxime Maho Loic Smal	10-21 17-21	18-21 18-21		R2
4		Bye	R1	R3	R2	

Classement	Pts	omb	Jeux	Points
1 Jules Challois Edouard Lardin	4	2	4 - 0	84 - 55
2 Jeet Singh Bhatia Sarvesh Jigjinni	2	2	2 - 2	70 - 78
3 Maxime Maho Loic Smal	0	2	0 - 4	63 - 84
4	0	0	0 - 0	0 - 0

# FSUB - Championnat

## DM5-6 - Groupe C

jeu. 02-12-21 11:41

BC de Marche

Badminton Tournament Planner

www.tournamentsoftware.com

	Club		1	2	3	4
1	ULB Ows - Université libre HEVinci - Haute Ecole Léopold	Martin Diederich Jorge Lopez Vasquez	X	12-21 21-23	16-21 21-18 21-18	21-16 21-16
2	Universiteit Gent Universiteit Gent	Joachim Bonte Thomas Schaep	21-12 23-21	X	17-21 24-22 21-15	21-16 19-21 21-16
3	UCLouvain Wolves - Université UCLouvain Wolves - Université	Noé Dubois Loup Struvay	21-16 18-21 18-21	21-17 22-24 15-21	X	20-22 20-22
4	KU Leuven KU Leuven	Jonathan Pijl Ruben Windey	16-21 16-21	16-21 21-19 16-21	22-20 22-20	X

Classement	Pts	Nombre	Jeux	Points
1 Joachim Bonte Thomas Schaep	6	3	6 - 2	167 - 144
2 Martin Diederich Jorge Lopez Vasquez	4	3	4 - 3	133 - 133
3 Jonathan Pijl Ruben Windey	2	3	3 - 4	129 - 143
4 Noé Dubois Loup Struvay	0	3	2 - 6	155 - 164

# FSUB - Championnat

DM5-6

Date  
01 déc. 2021

Ville, Pays  
Louvain-La-Neuve, BEL

Site WEB

Printed: 02-12-21 11:47:02

Club	Demi-finale	Finale	Vainqueur
1 Louvain-la-Neuve - Université catholique de Louvain Louvain-la-Neuve - Université libre de Bruxelles	<b>Florian Peeters [1]</b> <b>Timmy Pham</b>		
2	Bye 1	<b>Florian Peeters [1]</b> <b>Timmy Pham</b>	
3 Universiteit Gent Universiteit Gent	Joachim Bonte Thomas Schaep		
4 Haute Ecole Libre de Bruxelles Haute Ecole Francisco Ferrer	<b>Jules Challois [2]</b> <b>Edouard Lardin</b>	<b>Jules Challois [2]</b> <b>Edouard Lardin</b> 21-19 21-18	

mer. 01-12-21 19:45

# FSUB - Championnat

## DD1-2-3-4-5-6

jeu. 02-12-21 11:41

BC de Marche

Badminton Tournament Planner

www.tournamentsoftware.com

	Club		1	2	3
1	KU Leuven KU Leuven	<b>Elke Barbier [1]</b> <b>Thys Silke</b>		27-25 10-21 21-17	21-13 21-19
2	UCLouvain Wolves - Univ UCLouvain Wolves - Univ	<b>Yseult Canautte [2]</b> <b>Rachel Delforge</b>	25-27 21-10 17-21		21-17 21-13
3	Universiteit Gent Universiteit Gent	Sara Careelmont Jera Van Nieuwenhuysse	13-21 19-21	17-21 13-21	

Classement	Pts	omb	Jeux	Points
1 Elke Barbier Thys Silke	4	2	4 - 1	100 - 95
2 Yseult Canautte Rachel Delforge	2	2	3 - 2	105 - 88
3 Sara Careelmont Jera Van Nieuwenhuysse	0	2	0 - 4	62 - 84

# Résultats du Championnat FSUB de Course d'Orientation

Forêt de Soignes

(Rhode-Saint-Genèse)

Dimanche 5 décembre 2021



























Championnat de Belgique de l'Enseignement Universitaire et Supérieur  
05/12/2021 – Forêt de Soignes (Rhodes Saint-Genèse)

Dames : Noir très long  11200m  170m (1)

			[H:]M:S	min/km	
1.	 Marine SILLIEN	UCLouvain Wolves	1:06:26	7'28"	
2.	 Lucie ARNO	Université Libre de Bruxelles	1:06:37	7'29"	+0:11
3.	 Julia KREKELS	KU Leuven	1:15:23	8'28"	+8:57
4.	 Béatrice DE LONGUEVILLE	ASUB	1:17:12	8'40"	+10:46
5.	 Hannah THIELS	KU Leuven	1:17:14	8'41"	+10:48
6.	 Dorota KOSINSKA	C.O. Liège	1:17:44	8'44"	+11:18
7.	 Veerle TULLENEERS	Omega	1:20:26	9'02"	+14:00
8.	 Marie BOLZER	Université de Lorraine	1:28:45	9'58"	+22:19
9.	 Greet PERSOON	TROL	1:29:01	10'00"	+22:35
10.	 Coline DEBREUX	Université de Lorraine	1:31:09	10'14"	+24:43
11.	 Amandine MALENGREAU	C.O. Pégase	1:32:37	10'24"	+26:11
12.	 Sophie BROUCKAERT	KU Leuven	1:42:48	11'33"	+36:22
13.	 Emma PETITJEAN	UCLouvain Wolves	1:44:42	11'46"	+38:16
14.	 Elisabeth CHRISTIAENS	UCLouvain Wolves	1:59:35	13'26"	+53:09
15.	 An DUYCK	ASUB	2:12:12	14'51"	+1:05:46
NC	 Sandrine DEFRAIGNE	ASUB			

H:Noir très long  11200m  170m (42)

			[H:]M:S	min/km	
1.	 Clément DEMEUSE	UCLouvain Wolves	1:03:36	5'41"	
2.	 Evert LEEUWS	Antwerp Orienteers	1:05:06	5'49"	+1:30
3.	 Nathan ARONDEAU	Université de Lorraine	1:08:47	6'08"	+5:11
4.	 Simon KREKELS	KU Leuven	1:08:54	6'09"	+5:18
5.	 Simon ARNO	UCLouvain Wolves	1:15:18	6'43"	+11:42
6.	 Nicolas SILLIEN	C.O. Pégase	1:21:22	7'16"	+17:46
7.	 Nicolas TRIFFAUX	UCLouvain Wolves	1:22:45	7'23"	+19:09
8.	 Brent VLEUGELS	Antwerp Orienteers	1:23:08	7'25"	+19:32
9.	 Martin DE JAEGER	UCLouvain Wolves	1:24:42	7'34"	+21:06
10.	 Christophe GOUTAUDIER	Université de Lorraine	1:29:47	8'01"	+26:11
11.	 Matijs LOECKX	Omega	1:31:44	8'11"	+28:08
12.	 Julien DACHE	C.O. Pégase	1:33:49	8'23"	+30:13
13.	 Philippe DELANDMETER	ASUB	1:38:38	8'48"	+35:02
14.	 Adrien TKINT	ASUB	1:38:58	8'50"	+35:22
15.	 Frederik LOECKX	Omega	1:39:35	8'53"	+35:59
16.	 Grégoire THIRAN	UCLouvain Wolves	1:41:42	9'05"	+38:06
17.	 Antoine QUOIDBACH	UCLouvain Wolves	1:43:02	9'12"	+39:26
18.	 Corneel CASIER	Universiteit Gent	1:43:46	9'16"	+40:10
19.	 Jonathan CATOT	Ecole Royale Militaire	1:46:53	9'33"	+43:17
20.	 Gabriel ANDREUX	Université de Lorraine	1:48:54	9'43"	+45:18
21.	 Luis TASCÓN GUTIERREZ	ASUB	1:50:06	9'50"	+46:30
22.	 Hadrien PLANCQ	UCLouvain Wolves	1:50:38	9'53"	+47:02
23.	 Serge HERMAN	ASUB	1:51:15	9'56"	+47:39
24.	 Thibault PREVOST	UCLouvain Wolves	1:51:17	9'56"	+47:41
25.	Jean-Claude JIMENEZ	hamok	1:53:30	10'08"	+49:54
26.	James GOSSELET	UCLouvain Wolves	1:54:30	10'13"	+50:54

Championnat de Belgique de l'Enseignement Universitaire et Supérieur  
05/12/2021 – Forêt de Soignes (Rhodes Saint-Genèse)

27.		François PRIELS	UCLouvain Wolves	2:01:58	10'53"	+58:22
28.		Donald VAN BOVEN	TROL	2:03:14	11'00"	+59:38
29.		Philippe CREFCOEUR	Altaïr C.O.	2:12:18	11'49"	+1:08:42
30.		Maximilien ANNET	UCLouvain Wolves	2:16:10	12'09"	+1:12:34
31.		Philippe CLAPUYT	ASUB	2:24:09	12'52"	+1:20:33
32.		Marin POURKAT	Université de Lorraine	2:35:25	13'53"	+1:31:49
33.		Peter DENDAS	Indiv.	2:37:30	14'04"	+1:33:54
34.		Philippe HENNEBERT	Indiv.	2:37:44	14'05"	+1:34:08
35.		Georges RYKEN	Hainaut O.C.	2:42:03	14'28"	+1:38:27
36.		Francis ROULY	Hainaut O.C.	2:42:04	14'28"	+1:38:28
37.		Antoine BEAUCARNE	UCLouvain Wolves	11:31:42	61'46"	+10:28:06
38.		Iwan VIS	SUD O LUX	11:49:46	63'22"	+10:46:10
NCL		Edouard BAUSIER	Haute Ecole Léonard de Vinci			
NCL		Teo DIERICK	Haute Ecole Léonard de Vinci			
NCL		Paolo CONTI	Haute Ecole Léonard de Vinci			
NCL		Lorenzo DI MARCO	Haute Ecole Léonard de Vinci			



Résultats du Championnat FSUB  
de Cross Country  
Braine l'Alleud  
Samedi 13 novembre 2021





*CEDIMMO - 46e G.P. Gaston Reiff de Cross-country - Braine-l'Alleud*

## RESULTATS

Samedi 13 Novembre 2021

Parc du Cheneau

Braine-l'Alleud

Championnats Provinciaux du Brabant Wallon

Championnats de Belgique Universitaires et Hautes Ecoles

Un grand merci à l'Administration Communale et à la Police de Braine l'Alleud, à CEDIMMO sponsor principal de l'évènement, à InBW, à la SWDE, à l'Institut Paul Hartmann, à AG Insurance, à tous les sponsors de l'USBW, à tous les bénévoles sans qui l'organisation ne pourrait exister ainsi qu'à tous les athlètes présents.

Dank aan de Nederlandstalige clubs voor hun aanwezigheid en deelname



# Résultats : Cross court Dames Universitaires

Tour : \*

**Série : 1**

**OFFICIEL** (15:29:09)

Pos.	Doss.	Athlète	Cat.	Année	Cercle	Perf.	Infos
1	2167	Welsch, Milly (U Liège)	SEN F	2000	SER		
2	2256	Moulin, Marine (UCL Wolves)	SEN F	2000	BBS		
3	2359	Kouassi Aka, Oceane (ULB Owls)	SEN F	2002	OSGA		
4	2183	Bruno, Fiona (UCL Wolves)	SEN F	2001	OSGA		
5	2255	Mazzoli, Marie (UCL Wolves)	SEN F	2002	DAMP		
6	1377	Spiessens, Jana (Thomas Moore)	SEN F	2001	SPBO		
7	106	Kontinen, Klaara (VUB)	SEN F	1999	NA		
8	111	Draux, Céline (ULB Owls)	SEN F	1997	NA		
9	1089	Vandamme, Sybil (EPHEC)	SEN F	2000	ACKO		
10	2293	Kurza, Klaudia (ULB Owls)	SEN F	2002	RESC		
11	22	Tavernier, Lola (HE Vinci)	SEN F	2002	NA		
12	21	Pizzano, Maelle (HE Vinci)	SEN F	2002	NA		
13	15	Houben, Chloé (HE Vinci)	JUN F	2003	NA		
14	24	Van Nieuwenhuysse, Léa (HE Vinci)	SEN F	2002	NA		
15	5	Clement, Jennifer (HE Vinci)	SEN F	2000	NA		
16	125	Mulatin, Romane (HE Vinci)	SEN F	2002	NA		
17	127	Pardoms, Emilie (UCL Wolves)	SEN F	2000	NA		
18	8	Dumont, Margault (HE Vinci)	SEN F	2002	NA		
19	14	Hanquiniaux, Justine (HE Vinci)	SEN F	2001	NA		
20	25	Van Ooteghem, Nathanaelle (HE Vinci)	JUN F	2003	NA		
21	20	Michel, Kelly (HE Vinci)	SEN M	2001	NA		
22	26	Van Hemelryck, Juliette (HE Vinci)	SEN F	2002	NA		
23	9	Ergun, Hasret (HE Vinci)	SEN F	1999	NA		
24	2	Bossut, Stecy (HE Vinci)	SEN F	2001	NA		
25	10	Gillis, Camille (HE Vinci)	JUN F	2003	NA		
26	13	Hajji, Hinde (HE Vinci)	SEN F	1999	NA		
27	19	Martins Venancio, Anabela (HE Vinci)	SEN F	2001	NA		
28	7	De Keyzer, Alicia (HE Vinci)	SEN F	2002	NA		
29	3	Charlier, Anna (HE Vinci)	SEN F	2000	NA		
30	28	Zimmermann, Nina (HE Vinci)	SEN F	2000	NA		

# Résultats : Cross court Hommes Universitaires

Tour : \*

Série : 1

**OFFICIEL** (15:36:55)

Pos.	Doss.	Athlète	Cat.	Année	Cercle	Perf.	Infos
1	66	Delvoie, Maxime (UCL Wolves)	SEN M	1997	NA		
2	108	Vitse, Jasper (KUL)	SEN M	2000	NA		
3	611	Janton, Quentin (UCL Wolves)	JUN M	2003	ARCH		
4	74	Lerman, Martin (UCL Wolves)	SEN M	2002	NA		
5	680	Oldenhove, Martin (UCL Wolves)	JUN M	2003	CSDY		
6	2863	Chretien, Arthur (UCL Wolves)	SEN M	2000	USBW		
7	2828	Bayard, Julien (HEPL)	SEN M	2002	SER		
8	3108	De Coninck, Timothee (UCL Wolves)	SEN M	2002	DAMP		
9	2923	Francotte, Thibaut (UCL Wolves)	SEN M	1999	RIWA		
10	3204	Benouda, Nawfel (HE Vinci)	SEN M	1999	CSDY		
11	2887	Léonard, Louis (UCL Wolves)	SEN M	2000	CSDY		
12	82	Terlinden-Ruh, Pierre (UCL Wolves)	SEN M	1997	NA		
13	89	Oristil, Alexandre (HE Vinci)	M40	1978	NA		
14	119	Varsalona, Calogero (HE Vinci)	SEN M	1999	NA		
15	59	Herin, Niels (HE Vinci)	SEN M	2002	NA		
16	102	Schwindal, Dorian (HE Vinci)	SEN M	2002	NA		
17	44	Degand, David (HE Vinci)	SEN M	1999	NA		
18	57	Haremza, Antoine (HE Vinci)	SEN M	2002	NA		
19	97	Renauld, Noah (HE Vinci)	SEN M	2002	NA		
20	91	Othe, Romain (HE Vinci)	SEN M	2001	NA		
21	1929	Vandamme, Nathan (EPHEC)	SEN M	2002	ACKO		
22	116	Stegmann, Len (HE Vinci)	SEN M	2001	NA		
23	36	Belchior, Noé (HE Vinci)	JUN M	2003	NA		
24	40	Chantrenne, Robin (HE Vinci)	SEN M	2000	NA		
25	99	Roland, Evan (HE Vinci)	SEN M	2001	NA		
26	100	Roulet, Lucas (HE Vinci)	JUN M	2003	NA		
27	87	Murefu, Tom (HE Vinci)	SEN M	2002	NA		
28	34	Bazzo, Luca (HE Vinci)	SEN M	2002	NA		
29	49	Dugauquier, Rémi (HE Vinci)	SEN M	2002	NA		
30	105	Smidts, William (HE Vinci)	SEN M	2002	NA		
31	114	Snyers, Reginald (HE Vinci)	SEN M	1999	NA		

32	46	Didriche, Valentin (HE Vinci)	SEN M	2001	NA		
33	32	Baffrey, Louis (HE Vinci)	SEN M	2001	NA		
34	39	Bourgeois, Simon (HE Vinci)	SEN M	2002	NA		
35	96	Reghif Harraz, Soulaymane (HE Vinci)	SEN M	2002	NA		
36	117	Tonnaer, Arthur (HE Vinci)	SEN M	2001	NA		
37	35	Bekaert, Thomas (HE Vinci)	SEN M	1999	NA		
38	98	Rizzo, Noé (He Vinci)	JUN M	2003	NA		
39	45	Deweerd, Briec (HE Vinci)	SEN M	2000	NA		
40	31	Ambroes, Benjamin (HE Vinci)	SEN M	1998	NA		
41	54	Gapasin, Théo (HE Vinci)	SEN M	2002	NA		
42	88	Nsapu, Joseph (HE Vinci)	SEN M	2002	NA		
43	90	Ostrowiecki, Krystian (He Vinci)	SEN M	2001	NA		
44	58	HAWNA, Akeem (HE Vinci)	SEN M	2001	NA		
45	118	Van Brusselen, Alexis (HE Vinci)	SEN M	2002	NA		
46	48	Dimassi, Alaa (HE Vinci)	SEN M	2001	NA		
47	42	Czerwinski, Valentin (HE Vinci)	SEN M	1999	NA		
48	50	Eberlin, Scott (HE Vinci)	JUN M	2003	NA		
49	95	Rau, Emilien (HE Vinci)	SEN M	2001	NA		
50	101	Sakindi, Emmanuel-Celestin (HE Vinci)	SEN M	1995	NA		
51	104	Siametis, Dimitrios (HE Vinci)	SEN M	2001	NA		
52	94	Rachedi, Elies (HE Vinci)	JUN M	2003	NA		
53	56	Hanse, Sacha (HE Vinci)	SEN M	2002	NA		
54	55	Guillaume, Alexis (HE Vinci)	JUN M	2003	NA		
55	107	Camuroglu, Emre Can (VUB)	SEN M	1998	NA		

# Résultats : Cross Long Dames Universitaires

Tour : \*

Série : 1

**OFFICIEL** (15:19:29)

Pos.	Doss.	Athlète	Cat.	Année	Cercle	Perf.	Infos
1	1501	Boniver, Alice (KUL)	SEN F	2002	ACP		
2	129	x, x	SEN F	2000	NA		
3	2392	Sillien, Marine (UCL Wolves)	SEN F	2000	CSDY		
4	122	Vancolen, Elisa (UCL Wolves)	SEN F	2001	NA		
5	109	Arno, Lucie (ULB Owls)	SEN F	1999	NA		
6	596	Lombard, Maximilienne (ULB Owls)	JUN F	2003	OSGA		
7	1140	Van Breusegem, Nikita (U Gent)	SEN F	2002	ZA		
8	113	Gourichon, Amélia (HEPL)	SEN F	2000	NA		
9	110	Besson, Jeanne (HEPL)	SEN F	2000	NA		
10	12	Hage, Rosalie (HE Vinci)	SEN F	2000	NA		
11	6	Dauby, Florine (HE Vinci)	SEN F	1999	NA		
12	18	Martin, Clémentine (HE Vinci)	SEN F	2000	NA		
13	27	Vansteyvoort, Vanessa (HE Vinci)	SEN F	1991	NA		
14	16	Humblet , Laura (HE Vinci)	SEN F	1998	NA		
15	17	Ihnat, Hanna-Anzhela (HE Vinci)	SEN F	1996	NA		
16	1	Bidoul, Perrine (HE VINCI)	SEN F	2000	NA		

# Résultats : Cross Long Hommes Universitaires

Tour : \*

Série : 1

**OFFICIEL** (16:42:01)

Pos.	Doss.	Athlète	Cat.	Année	Cercle	Perf.	Infos
1	66	Delvoie, Maxime (UCL Wolves)	SEN M	1997	NA		
2	63	Crickillon, Tancrède (UCL Wolves)	SEN M	1999	NA		
3	2743	Willocq, Florian (HE2B)	SEN M	1999	OSGA		
4	68	Fiessinger, Nicolas (UCL Wolves)	SEN M	2000	NA		
5	2876	Willems, Oskar (UCL Wolves)	SEN M	1999	RIWA		
6	128	Vancolen, Pierre (UCL Wolves)	SEN M	2002	NA		
7	300	Vandermunter, Bastien (HE2B)	JUN M	2003	USBW		
8	2891	Delvoie, Basile (UCL Wolves)	SEN M	2000	CSDY		
9	619	Lengelé, Antoine (U Mons)	JUN M	2003	OSGA		
10	108	Vitse, Jasper (KUL)	SEN M	2000	NA		
11	2800	Mathurin, Aurian (HEH)	SEN M	2002	GOSP		
12	2887	Léonard, Louis (UCL Wolves)	SEN M	2000	CSDY		
13	78	Mattart, Antoine (HEPL)	JUN M	2003	NA		
14	2974	Bourez, Nicolas (UCL Wolves)	SEN M	2002	USBW		
15	3104	Delarge, Mathieu (HE Vinci)	SEN M	2000	RESC		
16	2895	Heroufosse, Baptiste (UCL Wolves)	SEN M	2002	CSDY		
17	77	Marlier, Quentin (HEPL)	SEN M	2002	NA		
18	80	Pirnay, Julien (U Liège)	SEN M	2001	NA		
19	69	Hendrix, Antoine (UCL Wolves)	SEN M	2000	NA		
20	81	Rens, Antoine (UCL Wolves)	SEN M	1996	NA		
21	72	Houis, Matheo (UCL Wolves)	SEN M	2000	NA		
22	1646	Corentin, Pierre (KUL)	SEN M	1998	DCLA		
23	83	Thiebaut, Louis (HELHA)	SEN M	2001	NA		
24	67	Faucheux, Victor (HEPL)	SEN M	2000	NA		
25	73	Houssiere, Pierre (UCL Wolves)	SEN M	2002	NA		
26	79	Morhet, Jerome (HEPL)	SEN M	1991	NA		
27	47	Dierick, Téo (HE Vinci)	SEN M	1999	NA		
28	41	Cowez, Romain (HE Vinci)	SEN M	2000	NA		
29	38	Borrens, Thibault (He Vinci)	SEN M	2000	NA		
30	51	Falmagne, Nicolas (HE Vinci)	SEN M	1999	NA		
31	115	Steels, Loic (HE Vinci)	SEN M	1998	NA		

32	103	Scourneau, Antoine (HE Vinci)	SEN M	2000	NA		
33	33	Bausier, Edouard (HE Vinci)	SEN M	1999	NA		
34	53	Galatanu, Angelo (HE Vinci)	SEN M	1998	EAH		
35	43	Defrenne, Sylvain (HE Vinci)	SEN M	1995	NA		



# Résultats du Championnat FSUB de Cyclisme Dames

Sinaii

Dimanche 1 mai 2022











# HoGent

# 01 MEI - SINAAI

## I.15 B NAT VROUWEN - IND - SINAAI

#DLN: 104 / #OPG: 17 / AFSTAND: 92.4KM / TIJD: 2H38'04" / GEM.SN: 35.07KM/H

**En bleu: classement du championnat FSUB du 1 mai 2022**

1	<b>FEDOTOVA KSENIIA</b> LVIV CYCLING TEAM  UKR19971230 ELITE	2H38'04"
2	<b>MILTENBURG ILSE</b>  NED19950817 DE	2H38'04"
3	<b>VAINIONPÄÄ LAURA</b> S-BIKES DOLTCINI  FIN19940411 DE	2H38'04"
4	<b>HEIJ SABINE</b> GC PAVÉ76  NED19980813 DE	2H38'04"
1	5 <b>SCAVONE DINA</b> S-BIKES DOLTCINI  BEL20010810 DE <b>Hogeschool PXL</b>	2H38'04"
6	<b>FEYTENS ELLEN</b> ASD WOMEN CYCLING PROJECT  BEL20000920 DE	2H38'04"
7	<b>TORTOLINA GAIA</b> ASD WOMEN CYCLING PROJECT  ITA19970629 DE	2H38'04"
8	<b>VAN BAKEL SOPHIE</b> LADIES CYCLING TEAM HOZ BEVEREN  NED19940706 DE	2H38'04"

2

9

**DECUYPERE RUTH** KDM-PACK CYCLING TEAM

BEL20030711 DE

**KU Leuven**

2H38´04"

10

**DALVING SHANA** KEUKENS REDANT CYCLING TEAM

BEL19940530 DE

2H38´04"

3

11

**BREUGELMANS ROSANNE** PISSEI - GROUP T.O.M.

BEL19980706 DE.UCI

**Universiteit Hasselt**

2H38´04"

12

**BASTIAENSSEN FAUVE** PISSEI - GROUP T.O.M.

BEL19971022 DE.UCI

2H38´04"

13

**CESCA BEATRICE** ASD WOMEN CYCLING PROJECT

ITA19000101 ELITE WOMEN

2H38´04"

4

14

**MALFAIT INES** ILLI-BIKES DEVO TEAM

BEL20000829 DE

**Hogeschool VIVES**

2H38´04"

5

15

**VAN ELSACKER FLOOR** ACROG-TORMANS

BEL20031024 DE

**Thomas Moore**

2H38´04"

6

16

**BAELE LOTTE** C.T. KEUKENS BUYSSE KNESSELARE VZW

BEL20030819 DE

**Artevelde Hogeschool**

2H38´04"

17

**HERMANS ANKA** LADIES CYCLING TEAM HOZ BEVEREN

BEL19960719 DE

2H38´04"

18

**MERTENS FIONA** BINGOAL-WB LADIES

BEL19961124 DE

2H38´04"

19

**BLONDÉ STEPHANIE** KEUKENS REDANT CYCLING TEAM

BEL19940702 DE

2H38´04"

20

**VROMANNE JUSTINE** BINGOAL-WB LADIES

BEL20010719 DE

2H38´04"

21

**DHONT GLACIA** KEUKENS REDANT CYCLING TEAM

BEL19990104 DE

2H38´04"

22

**LUKACHUK SOLOMIIA** LVIV CYCLING TEAM

UKR20010430 U23

2H38´04"

7

23

**POPPE FEBE** LADIES CYCLING TEAM HOZ BEVEREN

BEL20000714 DE

**Universiteit Gent**

2H38´04"

24

**ZWAENPOEL TESSA** PROXIMUS-ALPHAMOTORHOMES-DOLTCINI CYCLING TEAM

BEL20010927 DE.UCI

2H38´04"

25

**PEREKITKO KAROLINA** MASSI TACTIC WOMEN TEAM

POL19981001 U23

2H38´04"

26

**COUDEVILLE HERLINDE** LADIES CYCLING TEAM HOZ BEVEREN

BEL19940829 DE

2H38´04"

27

**VANDEWALLE ISABEL** BINGOAL-WB LADIES

BEL19960606 DE

2H38´04"

28

**DE SCHEPPER JASMINE** KEUKENS REDANT CYCLING TEAM

BEL19980813 DE

2H38´04"

29

**VERSTICHELEN FEMKE** ASD WOMEN CYCLING PROJECT

BEL19840322 DE

2H38´04"

30

**DEBBOUDT LENSY** KEUKENS REDANT CYCLING TEAM

BEL19770920 DE

2H38´04"

31

**VAN LATHEM BARBARA** BATAIA BRIGADE

BEL19880701 DE

2H38´04"

8

32

**HUVENNE MARIE** ROYAL CUREGHEM SPORTIEF VZW

BEL20010309 DE

**Thomas Moore**

2H38´04"

33

**VAN GOETHEM FEMKE** KEUKENS REDANT CYCLING TEAM

BEL20020116 DE

2H38´04"

34

**AYROUD KATHRYN** CC PAVÉ76

CAN19000101 U23 WOMEN

2H38´04"

9

35

**SADOINE PERRINE** BINGOAL-WB LADIES

BEL20010731 DE

**HEPH - Condorcet**

2H38´04"

36

**VERONI ELEONORA** ASD WOMEN CYCLING PROJECT

ITA19000101 ELITE WOMEN

2H38´04"

10

37

**BROUCKAERT SOPHIE** KDM-PACK CYCLING TEAM

BEL20011102 DE

**KU Leuven**

2H38´04"

11

38

**D´HAUWE SILKE** CYCLINGTEAM BELCO/VAN EYCK

BEL19981128 DE

**Universiteit Gent**

2H38´04"

39

**DEBBOUDT EVELIEN** KEUKENS REDANT CYCLING TEAM

BEL19840924 DE

2H38´04"

40

**DE BRUYNE MEG** PROXIMUS-ALPHAMOTORHOMES-DOLTCINI CYCLING TEAM

BEL19960923 DE

2H38´04"

41

**EVANS ALICIA** LVIV CYCLING TEAM

NZL19870702 ELITE WOMEN

2H38´04"

42

**DENEEF NAÏKA** BINGOAL-WB LADIES

BEL19940913 DE

2H38´04"

43

**LEURS INES** CYCLINGTEAM BELCO/VAN EYCK

BEL19980312 DE

2H38´04"

44

**KEMPS STEPHANIE** CYCLINGTEAM BELCO/VAN EYCK

BEL20020502 DE

2H38´04"

45

**DE VEIRMAN FLEUR** CYCLINGTEAM BELCO/VAN EYCK

BEL20030806 DE

2H38´04"

12

46

**GOESSENS BRENDA** KEUKENS REDANT CYCLING TEAM

BEL19980504 DE

**Hogeschool Gent**

2H38´04"

47

**HARGREAVES SAMANTHA** ILLI-BIKES DEVO TEAM

CAN20010405 DE

2H38´04"

48

**VAN DEN STEEN KIM** ISOREX CYCLING TEAM

BEL19940526 DE

2H38´04"

	49	<b>MICHOTTE MAËLLE</b> BINGOAL-WB LADIES  BEL20020417 DE	2H38´04"
13	50	<b>AERTS KATO</b> ASFRA RACING TEAM  BEL20020909 DE <b>Hogeschool PXL</b>	2H38´04"
	51	<b>VERSCHELDEN NATHALIE</b> S-BIKES DOLTCINI  BEL19940726 DE	2H38´04"
	52	<b>NOBUS JASMIRA</b> KDM-PACK CYCLING TEAM  BEL20030328 DE	2H38´04"
	53	<b>PULLES LINDA</b> GC PAVE76  NED19971112 ELITE VROUWEN	2H38´04"
	54	<b>DEREERE MACHALINA</b> KDM-PACK CYCLING TEAM  BEL19910406 DE	2H38´04"
	55	<b>LENS AN</b> LADIES CYCLING TEAM HOZ BEVEREN  BEL19850522 DE	2H38´04"
	56	<b>SHARHA OLENA</b> NATIONAL TEAM UKRAINE  UKR19861221 ELITE WOMEN	2H38´04"
14	57	<b>VAN NUFFELEN LIESELOTTE</b> LADIES CYCLING TEAM HOZ BEVEREN  BEL20020425 DE <b>UCLLimburg</b>	2H38´04"
15	58	<b>DE VOS NELE</b> NEVER GIVE UP BY JOLIEN VERSCHUEREN  BEL19980824 DE <b>Universiteit Gent</b>	2H38´04"

16	59	<b>VAN DE VELDE FLORELIEN</b> KDM-PACK CYCLING TEAM  BEL20010110 DE <b>Universiteit Gent</b>	2H38´04"
17	60	<b>VAN LOMMEL YENTHE</b> CYCLINGTEAM BELCO/VAN EYCK  BEL20020118 DE <b>Thomas Moore</b>	2H38´04"
18	61	<b>PANNECOUCKE CAILY</b> ASFRA RACING TEAM  BEL20010605 DE <b>Universiteit Gent</b>	2H38´04"
	62	<b>GORT FEMKE</b> BNS TECHNICS-GROUP T.O.M.  NED20031009 DE	2H38´04"
	63	<b>HÄMÄLÄINEN AINO</b> PORIN TARMO  FIN19000101 U23 WOMEN	2H38´04"
	64	<b>VAN DEN BORN EVA</b> CYCLING TEAM BELCO - VAN EYCK  NED19921230 DE	2H38´04"
	65	<b>BONTHUIS LORA</b> JVR DE BATAUWERS  NED19000101 U23 WOMEN	2H38´04"
	66	<b>SLEGERS REINE</b> INDIVIDUEEL  BEL20000630 DE	2H38´04"
	67	<b>VERSTRATEN CHANTAL</b> WIELERVERENIGING BREDA  NED19000101 AMATEUR WOMEN	2H38´04"
	68	<b>VRANKEN CHAYENNE</b> CYCLINGTEAM BELCO/VAN EYCK  BEL19990908 DE	2H38´04"



69

**RIETJENS DORIEN** BINGOAL-WB LADIES

BEL19960402 DE

2H38´04"

70

**ADRIAANSEN MAUD** AR EN TV DE ADELAAR

NED20010629 U23 WOMEN

2H38´04"

71

**HAERS CAROLIEN** BINGOAL-WB LADIES

BEL19831006 DE

2H38´04"

72

**JONGENELEN SANNE** RTV DE BOLLENSTREEK

NED20010916 DE

2H38´04"

73

**BORREMANS SARAH** LVIV CYCLING TEAM

BEL19880804 DE

2H38´04"

19

74

**UYTTENHOVE AIKO** BATAIA BRIGADEBEL20001124 DE [Universiteit Gent](#)

2H38´04"

75

**TEN HARTOG SARAH** WIELERCLUB DE SPRINTERS MALDEREN

BEL19861210 DE

2H38´04"

76

**COUMANS LIESKE** WV DE JONGE RENNER OOSTERHOUT

NED19920407 ELITE WOMEN

2H38´04"

77

**ACKE DAPHNÉ** WIELERTEAM DECOCK-VAN EYCK-VAN MOSSEL DEVOS-CAPOEN

BEL19930608 DE

2H38´04"

78

**KLIMCHENKO TETYANA** LVIV CYCLING TEAM

UKR19940508 ELITE

2H38´04"

20 79 DEBAERE ANSE KDM-PACK CYCLING TEAM  
 BEL20010818 DE Hogeschool VIVES

2H38´04"

80 KUIJSTERMANS DEVON ISOREX CYCLING TEAM  
 NED19930914 DE

2H38´04"

81 LEENKNEGT LILIANE BINGOAL-WB LADIES  
 BEL19781221 DE

2H38´04"

21 82 DHONT KIONA VONDELMOLEN-DE GEUSTER CYCLING TEAM  
 BEL20030109 DE Odisee Hogeschool

2H38´04"

83 MARIEN LYNN CYCLINGTEAM BELCO/VAN EYCK  
 BEL19980630 DE

2H38´04"

84 APERS NICKY LADIES CYCLING TEAM HOZ BEVEREN  
 BEL19901030 DE

2H38´21" +0´17"

85 MOREAU MARJOLEIN ISOREX CYCLING TEAM  
 BEL19980610 DE

2H38´44" +0´40"

22 86 BAUTE MORGANE KDM-PACK CYCLING TEAM  
 BEL20020304 DE Hogeschool West-Vlaanderen

2H38´44" +0´40"

23 87 SNAUWAERT YARA KDM-PACK CYCLING TEAM  
 BEL20030916 DE Universiteit Gent

2H38´44" +0´40"

DNF GEOGHEGAN MICHELLE ISOREX CYCLING TEAM  
 IRL19820621 DE

DNF

DNF

NUIJENS PATRICIA LADIES CYCLING TEAM HOZ BEVEREN



NED19930317 DE

DNF

DNF

VERDICKT STEFFI ACROG-TORMANS



BEL19920321 DE

DNF

DNF

VANDERHEYDEN LIENA ROYAL CUREGHEM SPORTIEF VZW



BEL19981208 DE

Vrije Universiteit Brussel

DNF

DNF

ROBBERECHT MEREL LADIES CYCLING TEAM HOZ BEVEREN



BEL20030116 DE

DNF

DNF

VERMINCKSEL CARMEN INDIVIDUEEL



BEL19931005 AM19V

DNF

DNF

SEYNAEVE ANNE-CHARLOTTE INDIVIDUEEL



BEL19950721 DE

DNF

DNF

CEULEMANS LISSE KDM-PACK CYCLING TEAM



BEL20020109 DE

Hogeschool Gent

DNF

DNF

WILLAERT LAURA CYCLINGTEAM BELGO/VAN EYCK



BEL20030926 DE

Universiteit Gent

DNF

DNF

COOLS AAIKE LADIES CYCLING TEAM HOZ BEVEREN



BEL20030228 DE

Universiteit Antwerpen

DNF

DNF

THILL LAURENCE WIELERCLUB DE SPRINTERS MALDEREN



LUX19950607 DE

DNF

DNF

**HEGGERICK ASTRID** BATAIA BRIGADE



BEL19990209 AM19V

DNF

DNF

**DE KEYSER EMKE** KDM-PACK CYCLING TEAM



BEL20030425 DE

**Hogeschool West- Vlaanderen**

DNF

DNF

**LINDÉN URSULA** PORIN TARMO



FIN19000101 U23 WOMEN

DNF

DNF

**BERKANE SARAH** ECVB-ANDY SCHLECK IMMO LOSCH



FRA20001019 DE

DNF

DNF

**ACCOE JOYCE** CAMPE CYCLING TEAM



BEL19870225 DE

DNF

DNF

**VAN HECKE XENA** KDM-PACK CYCLING TEAM



BEL20010228 DE

DNF

# Résultats du Championnat FSUB de Cyclisme Hommes

Zomergem

Mardi 28 juin 2022



# HoGent

# 28 JUN. - KON.WIELERCLUB "DE SPORTVRIENDEN" ZOMERGEM

## HOOFDREEKS

#DLN: 87 / #OPG: 15 / AFSTAND: 104.4KM / TIJD: 2H32´16" / GEM.SN: 41.06KM/H

### En Bleu: Classement du championnat FSUB du 28 juin 2022

1	<b>DE DECKER BJORN</b> JOHN SAEY CYCLING TEAM  BEL19881010 EL319+	2H32´16"
2	<b>VAN DYCK WESLEY</b> SHIFTING GEARS X BLACK SHEEP  BEL19940915 ELITE2	2H32´16"
3	<b>DEMOLDER THOMAS</b> VAN MOSSEL HEIST CYCLING TEAM  BEL19960822 ELITE2	2H32´16"
4	<b>DESMECHT DAVID</b> S-BIKES DOLTCINI  BEL19921222 ELITE2	2H32´16"
5	<b>GREEN BRENDON</b> BLACKBURN CYCLING CLUB  AUS19970415 ELITE MEN	2H32´16"
6	<b>DE SCHEEMAEKER DAVY</b> VETRAPO - B-CLOSE CYCLING TEAM  BEL19870626 ELITE2	2H32´16"
7	<b>COPPENS TIM</b> VETRAPO - B-CLOSE CYCLING TEAM  BEL19900613 ELITE2	2H32´16"
8	<b>ROESEMS SIEBE</b> TRINITY RACING  BEL20010608 U23.C	2H32´26" +0´10"

	9	<b>DECABOOTER LANCE</b> VDM-TRAWOBO CYCLING TEAM  BEL20010822 U23		2H32´26" +0´10"
	10	<b>VAN RENTERGHEM BRAM</b> CAMPE CYCLING TEAM  BEL19950724 ELITE2		2H32´26" +0´10"
	11	<b>PARIDAENS JASPER</b> RB ZELFBOUW UCT  BEL19950418 ELITE2		2H32´26" +0´10"
1	12	<b>VANACKER EMIEL</b> URBANO-VULSTEKE CT  BEL20020508 U23 <b>HOWEST</b>		2H32´37" +0´21"
	13	<b>DE SCHUYTER ARNE</b> VETRAPO - B-CLOSE CYCLING TEAM  BEL19920630 ELITE2		2H32´37" +0´21"
2	14	<b>DE NEVE JOERIK</b> VDM-TRAWOBO CYCLING TEAM  BEL19990830 ELITE2 <b>UGENT</b>		2H32´37" +0´21"
	15	<b>MAGINET STEVE</b> HOME SOLUTION - SOENENS CYCLING TEAM  BEL19801227 ELITE2		2H32´37" +0´21"
3	16	<b>SANDRIE BRENT</b> KDM-PACK CYCLING TEAM  BEL20010710 U23 <b>HOGent</b>		2H32´37" +0´21"
4	17	<b>DE BROEDER MAXWELL</b> SHIFTING GEARS X BLACK SHEEP  BEL19990506 ELITE2 <b>HOGent</b>		2H32´37" +0´21"
	18	<b>BULTYNCK ISAAK</b> INDIVIDUEEL  BEL19810624 MASM		2H32´37" +0´21"

	19	<b>HOLVOET MATHIJS</b> DAGPAS  BEL19000101		2H32´37" +0´21"
	20	<b>PIETERS BJARNE</b> CAMPE CYCLING TEAM  BEL20011017 U23		2H32´37" +0´21"
	21	<b>OLIEBOS JORDY</b> INDIVIDUEEL  BEL19950407 EL319+		2H32´37" +0´21"
	22	<b>CLAES DRIES</b> SHIFTING GEARS X BLACK SHEEP  BEL19880817 EL319+		2H32´37" +0´21"
	23	<b>VAN HYFTE STEVEN</b> INDIVIDUEEL  BEL19840409 MASM		2H32´37" +0´21"
5	24	<b>HEYMAN JASPER</b> VETRAPO - B-CLOSE CYCLING TEAM  BEL20031022 U23 <b>VIVES</b>		2H32´37" +0´21"
6	25	<b>BOELAERT MATISSE</b> CRABBE TOITURES - CC CHEVIGNY  BEL20001121 U23 <b>Artevelde</b>		2H32´37" +0´21"
	26	<b>CORDEEL PIETER</b> DCR CYCLING TEAM  BEL19890328 ELITE2		2H32´37" +0´21"
7	27	<b>DEDEURWAERDERE BRICE</b> COMITE REGIONAL BRABANT-WALL.  BEL20020320 U23 <b>HE Vinci</b>		2H32´37" +0´21"
	28	<b>DE SCHUYTER TIM</b> INDIVIDUEEL  BEL19930413 ELITE2		2H32´37" +0´21"



8

29

VERGRUYSSSE GILLES VZW WP DE MOLENSPURTERS MEULEBEKE



BEL20000516 U23

VIVES

2H32´37" +0´21"

30

DE GRAEVE BRIAN VANOMOBIL MTB CYCLING TEAM



BEL19990106 ELITE2

2H32´37" +0´21"

31

DOCKX KRISTOF STAGECO CYCLING TEAM



BEL19921204 ELITE2

2H32´37" +0´21"

32

VAN DER PLAETSEN DAMON KON. VC ´T MEETJESLAND - KNESSELARE



BEL20010327 U23

2H32´37" +0´21"

9

33

VAN LIPPEVELDE SANDER ALFASUN ALFACOOOL CYCLING TEAM



BEL19990313 ELITE2

UGENT

2H32´37" +0´21"

34

VAGENENDE LIAM TEAM THIELEMANS - DE HAUWERE



BEL19990326 ELITE2

2H32´37" +0´21"

10

35

BONTINCK JARNE CYCLING TEAM DAKWERKEN STROOBANT



BEL20011205 U23

UGENT

2H32´37" +0´21"

36

VANDEWIELE FREDERIK VETRAPO - B-CLOSE CYCLING TEAM



BEL19910211 ELITE2

2H32´37" +0´21"

11

37

VAN DE VELDE SENNE RB ZELFBOUW UCT



BEL20021105 U23

UGENT

2H32´37" +0´21"

38

VISPOEL RUBEN INDIVIDUEEL



BEL19900623 EL319+

2H32´37" +0´21"

39

**FORRIER GIANNI** CAMPE CYCLING TEAM  
 BEL20000715 U23 **VIVES**

2H32´37" +0´21"

40

**VERMEIREN STEF** KON. VC ´T MEETJESLAND - KNESSELARE  
 BEL20020204 U23

2H32´37" +0´21"

41

**RONSSSE GAUTHIER** JOHN SAEY CYCLING TEAM  
 BEL19961113 EL319+

2H32´37" +0´21"

42

**CLAEYS TIMOTHY** CAMPE CYCLING TEAM  
 BEL19920312 ELITE2

2H32´37" +0´21"

43

**JACOBS BJORN** DAGPAS  
 BEL19000101

2H32´37" +0´21"

44

**DE WISPELAERE ARNO** CYCLING TEAM THE BANANAS  
 BEL19890318 EL319+

2H32´37" +0´21"

45

**VAN DE WALLE BRENT** KON. VC ´T MEETJESLAND - KNESSELARE  
 BEL19930920 ELITE2

2H32´37" +0´21"

46

**VAN STEENBERGE DAVID** INDIVIDUEEL  
 BEL19891125 ELITE2

2H32´37" +0´21"

47

**POPPE STEF** INDIVIDUEEL  
 BEL19930618 EL319+

2H32´37" +0´21"

48

**BEKAERT LAURENS** INDIVIDUEEL  
 BEL19870911 ELITE2

2H32´37" +0´21"

49

**DE BAETS KRISTOF** CYCLING TEAM THE BANANAS BEL19841120 MASM

2H32´37" +0´21"

50

**DE MEYDTS SVEN** INDIVIDUEEL BEL19870901 EL319+

2H32´37" +0´21"

51

**VALCKE OWEN** DEBO-BIKES OFF-ROAD TEAM BEL19990514 ELITE2

2H32´37" +0´21"

52

**VAN DAELE NILS** DAGPAS BEL19000101

2H32´37" +0´21"

53

**ROELS MICHAËL** DE MARTLÉ´S BEL19850109 MASM

2H32´37" +0´21"

54

**VANDENDRIESSCHE IBE** INDIVIDUEEL BEL19901123 EL319+

2H32´37" +0´21"

55

**VERSCHAEREN NIELS** DAGPAS BEL19000101

2H32´37" +0´21"

56

**ANDRIES KEVIN** INDIVIDUEEL BEL19870504 MASM

2H32´37" +0´21"

13

57

**DE KEE GLENN** ALFASUN ALFACOOOL CYCLING TEAM BEL19981114 ELITE2 **UGENT**

2H32´37" +0´21"

58

**MEYSMAN MICHEL** INDIVIDUEEL BEL19761122 MASM

2H32´37" +0´21"

59

DE GRAEVE JASON VANOMOBIL MTB CYCLING TEAM

 BEL20001230 U23

2H32´37" +0´21"

60

DEPRAETERE ROEL DAGPAS

 BEL19000101

2H32´37" +0´21"

61

VOSSAERT MATTHIAS INDIVIDUEEL

 BEL19890629 EL319+

2H32´37" +0´21"

62

TRIBOUT BART HOME SOLUTION - SOENENS CYCLING TEAM

 BEL19820507 ELITE2

2H32´37" +0´21"

14

63

BRESSELEERS JONAS VAN MOSSEL HEIST CYCLING TEAM

 BEL19990917 ELITE 2 **AP**

2H32´37" +0´21"

64

LUMINI VINCENZO JONGE RAKKERS VOLLEZELE

 ITA20000901 U23

2H32´37" +0´21"

65

DE JAEGHERE RUBEN KDM-PACK CYCLING TEAM

 BEL19970716 ELITE2

2H32´37" +0´21"

66

VAN HYFTE TOM DAGPAS

 BEL19000101

2H32´37" +0´21"

67

VANSPEYBROECK SAM DAGPAS

 BEL19000101

2H32´37" +0´21"

68

D´HOORE MAARTEN DAGPAS

 BEL19000101

2H32´37" +0´21"

69

VERVYNCK PETER CYCLING TEAM THE BANANAS

 BEL19840719 MASM

2H32´37" +0´21"

70

SCHRIJVERS KURT TEAM THIELEMANS - DE HAUWERE

 BEL19780307 ELITE2

2H32´37" +0´21"

71

ALONSO ALEXANDER SHIFTING GEARS X BLACK SHEEP

 BEL19761226 MASM

2H32´37" +0´21"

72

DE FAUW WOUTER WAOD

 BEL19931221 WAOD

2H32´37" +0´21"

15

DNF

GOFFIN ALEXANDRE ENTENTE CYCLISTE DE WALLONIE

 BEL20021210 U23 **UCLouvain Wolves**

DNF

15

DNF

LEYMAN CELESTIN DUNKERQUE LITTORAL CYCLISME

 BEL19970329 ELITE2 **UGENT**

DNF

DNF

MALLEZIE SVEN TEAM ADAPP

 BEL19821214 MASM

DNF

DNF

DE RHO NICOLAY HORS CATÉGORIE CC

 BEL19970313 EL319+

DNF

15

DNF

MONTFILS THIBAUT DAGPAS

 BEL19000101 **UCLouvain Wolves**

DNF

1515 DNF

TRIFIRO NORDIN DAGPAS

 BEL19000101 **UCLouvain Wolves**

DNF

15

DNF

TRUJILLO RAPHAEL BRUSSELS BIG BRACKETS

BEL19990209 EL319+ **HELB**

DNF

15

DNF

BAUDIN GUILHEM DAGPAS

BEL19000101 **HE Vinci**

DNF

15

DNF

VAN LIERDE DIEGO DAGPAS

BEL19000101 **HE Vinci**

DNF

DNF

EVRAERT NIELS INDIVIDUEEL



BEL19951016 EL319+

DNF

DNF

VANTORRE VINCENT INDIVIDUEEL



BEL19821219 MASM

DNF

DNF

BOLLE ANDY ALFASUN ALFACOOOL CYCLING TEAM



BEL19911228 ELITE2

DNF

DNF

LAMMENS MARIO INDIVIDUEEL



BEL19651114 MASM

DNF

DNF

LAMMENS LAUDELINO INDIVIDUEEL



BEL19910327 EL319+

DNF

15

DNF

ROBERT GUILLAUME ROYAL CYCLISTS PESANT CLUB LIEGEOIS

BEL20010518 U23 **HE Vinci**

DNF

# Résultats du championnat FSUB d'Échecs

UAntwerpen

Mardi 22 février 2022



#	Name	First name	X	fed	Institution	ELO	FIDE ID	Resultat	Ladies
18	Dallemagne	Maximilien	M	ASEUS	UCLouvain Wolves	1927	236543	1	
21	De Block	Yordi	M	SSV	HOGENT	2076	214175	2	
4	Aguilar	Luciano	M	ASEUS	ULB Owls	1741	249831	3	
64	Van Dijck	Bjarne	M	SSV	UAntwerpen	2087	239348	4	
12	Butzen	Robin	M	SSV	KU Leuven	2008	244392	5	
3	Aguilar	Adriano	M	ASEUS	ULB Owls	1750	249823	6	
54	Rotaru	Teodor	M	SSV	KU Leuven	1922	1207377	7	
29	Deneuille	Walter	M	ASEUS	ULB Owls	1700		8	
41	Lascar	Radosława	V	SSV	AP	1636	1148761	9	F-1
14	Carati	Félix	M	ASEUS	ULB Owls	***		10	
26	Debaere	Thomas	M	SSV	UGent	***		11	
16	Coucke	Yari	M	SSV	VIVES	1900		12	
68	Vernimmen	Pierre	M	ASEUS	UCLouvain Wolves	1876	251917	13	
22	de Brier	Aurian	M	ASEUS	UCLouvain Wolves	1690	256382	14	
51	Pouliart	Sander	M	SSV	UAntwerpen	1434	251062	15	
11	Burignat	Yohan	M	ASEUS	UCLouvain Wolves	1716	259888	16	
17	Dallemagne	Brieuc	M	ASEUS	UCLouvain Wolves	1617	237760	17	
30	Denis	Romain	M	ASEUS	ULB Owls	1600		18	
55	Rousseau	Christilla	V	SSV	KU Leuven	1656	251801	19	F-2
19	De Baets	Keano	M	SSV	KU Leuven St Lucas Gent	1698	247758	20	
53	Rößler	Christian	M	ASEUS	ERM	1600		21	
66	Van Steirteghem	Eliott	M	ASEUS	ULB Owls	***		22	
1	Abrahams	Sander	M	SSV	KU Leuven	1600		23	
6	Arakelyan	Narek	M	SSV	UAntwerpen	1350		24	
9	Bruyland	Simeon	M	SSV	UGent	0		25	
15	Coenen	Jonah	M	SSV	KU Leuven	***	270873	26	
40	Langlet	Maxime	M	ASEUS	ULB Owls	1000		27	
70	Nazarov	Kirill	M	ASEUS	ULB Owls	***		28	
60	Standaert	Matias	M	ASEUS	UCLouvain Wolves	***		29	
63	van Betsbrugge	Ewout	M	SSV	KU Leuven	***		30	
5	Rabah	Ahmad	M	SSV	KU Leuven	1800		31	
44	Meersman	Nicolas	M	SSV	KU Leuven KULAK	1800		32	
35	Gottfried	Simon	M	SSV	Thomas More	0		33	
7	Beerlandt	Jules	M	SSV	KU Leuven KULAK	1600		34	
36	Guillaume	Félix	M	ASEUS	UCLouvain Wolves	***		35	
47	Oud	Ruben	M	ASEUS	ERM	1100		36	
38	Hoet	Nathan	M	ASEUS	UCLouvain Wolves	1000		37	
24	De Praitere	Hannes	M	SSV	KU Leuven	0	270318	38	
43	Lotfi	Ayoub	M	SSV	UAntwerpen	1000		39	
62	Topollaj	Evis	M	SSV	Thomas More	1200		40	
31	Dietvorst	Seppe	M	ASEUS	ERM	***		41	
34	Gombosuren	Kristina	V	SSV	VIVES	0		42	F-3
69	wuyts	seppe	M	SSV	UAntwerpen	***		43	
59	Smis	Gavroche	M	SSV	Artevelde	1100		44	
37	Heylen	Noah	M	SSV	HOGENT	0		45	
13	Cailteux	Thomas	M	ASEUS	UCLouvain Wolves	***		46	
67	Verbist	Gijs	M	SSV	AP	1150		47	
2	Acke	Pierre	M	SSV	Odisee	***		48	
8	Bellégou	Glenn	M	SSV	UCLL Leuven	***		49	
23	de Condé	Léopold	M	ASEUS	UCLouvain Wolves	***		50	
50	Potters	Dominic	M	SSV	UAntwerpen	1000		51	
20	De Beenhouwer	Therenty	M	SSV	KU Leuven	1750		52	
58	Servais	Arnaud	M	ASEUS	UCLouvain Wolves	***		53	
42	Lips	Reinaud	M	SSV	UHasselt	0		54	
39	Kiekens	Thomas	M	ASEUS	UCLouvain Wolves	***		55	



45	Merveille	Lander	M	SSV	Howest	1100		56
49	Pire	Victor	M	ASEUS	ULB Owls	1500		57
57	Schmit	Manon	V	ASEUS	UCLouvain Wolves	***		58
33	Godochian	George	M	ASEUS	UCLouvain Wolves	***		59
10	Bundotich	Brian	M	SSV	Thomas More	500		ABS
25	De Vleeschauwer	Maarten	M	SSV	UGent	2204	214809	ABS
28	Demey	Lotte	V	SSV	HOGENT	1561		ABS
32	Friedman	Shneor	M	SSV	KdG	1150		ABS
48	Peeters	Ruben	M	SSV	UGent	***		ABS
52	Raj	Karki	M	SSV	VIVES	***		ABS
56	Ryelandt	Bastien	M	ASEUS	UCLouvain Wolves	***		ABS
61	Steemans	Marnix	M	ASEUS	ERM	***		ABS
65	Van Neer	Seppe	M	SSV	UGent	***		ABS



# BSK Schaken / FSUB Echecs 2021-22

## Final Ranking

3/12/2021 - Hof van Liere, University of Antwerp (Belgium)

Referee: Patrick Van de Perre

Pace: 3'+2"

F	#	Name Firstname	Nr	Rnk	Institute	M/V	Elo	Fide	EloUsed	Title	Games	Pts	XtPts	P.Tot.	Perf	B Cut1	Buch	S.B.	Prog.	DirEn
	1	Dallemagne, Maximilien	40	4	UCLouvain Wolves	M	2089	1927	2089		7	6.5	0.0	6.5	2232	28.00	31.00	28.25	26.5	-
	2	De Block, Yordi	5	3	HOGENT	M	2090	2058	2090		7	5.5	0.0	5.5	2067	29.50	31.00	22.75	25.0	-
	3	Aguilar, Luciano	61	11	ULB Owls	M	1770	1741	1770		7	5.5	0.0	5.5	1971	29.00	30.50	21.25	24.5	-
	4	Van Dijck, Bjarne	34	2	UAntwerpen	M	2112	2119	2112		7	5.5	0.0	5.5	2020	28.50	31.50	24.00	23.0	-
	5	Butzen, Robin	16	5	KU Leuven	M	2016	1766	2016		7	5.5	0.0	5.5	1944	24.50	27.00	20.25	22.5	-
	6	Aguilar, Adriano	60	9	ULB Owls	M	1823	1754	1823		7	5.0	0.0	5.0	1868	28.00	30.00	18.00	22.0	-
N	7	Rotaru, Teodor	20	7	KU Leuven	M	0	1922	1922		7	5.0	0.0	5.0	1835	27.50	30.00	18.50	22.0	-
N	8	Deneuille, walter	63	14	ULB Owls	M	1700	0	1700		5	4.0	1.0	5.0	1776	26.50	29.50	17.00	13.0	-
N	9	Lascar, Radoslawa	1	18	AP	V	0	1636	1636		7	5.0	0.0	5.0	1759	26.00	29.00	18.50	21.0	-
N	10	Carati, Félix	62	66	ULB Owls	M	0	0	0		7	5.0	0.0	5.0	1534	25.00	28.00	19.00	19.0	-
N	11	Debaere Thomas	54	61	UGent	M	0	0	0		7	5.0	0.0	5.0	1421	18.00	19.50	13.00	17.0	-
N	12	Coucke, Yari	68	8	VIVES	M	1900	0	1900		7	4.5	0.0	4.5	1830	28.50	31.00	17.25	22.0	-
	13	Vernimmen, Pierre	51	6	UCLouvain Wolves	M	1978	1876	1978		7	4.5	0.0	4.5	1798	27.50	31.00	18.75	20.0	-
	14	De Briey, Aurian	41	17	UCLouvain Wolves	M	1637	1549	1637		7	4.5	0.0	4.5	1624	27.00	28.00	15.75	19.0	-
	15	Pouliart, Sander	33	28	UAntwerpen	M	1383	1184	1383		7	4.5	0.0	4.5	1424	23.50	24.50	13.50	18.0	-
N	16	Burignat, Yohan	37	13	UCLouvain Wolves	M	1718	1716	1718		7	4.5	0.0	4.5	1577	21.00	22.50	13.25	19.0	-
N	17	Dallemagne, Brieuc	39	19	UCLouvain Wolves	M	1633	1617	1633		7	4.0	0.0	4.0	1479	26.50	29.50	15.50	18.5	-
N	18	Denis, Romain	64	23	ULB Owls	M	1600	0	1600		7	4.0	0.0	4.0	1484	26.00	29.00	14.25	17.0	-
	19	Rousseau, Christilla	21	16	KU Leuven	V	1662	1625	1662		7	4.0	0.0	4.0	1571	26.00	28.50	12.50	19.0	-
	20	De Baets, Keano	25	15	KU Leuven St Lucas Gent	M	1690	1632	1690		7	4.0	0.0	4.0	1553	25.50	28.50	13.00	19.0	-
N	21	Rössler, Christian	7	20	ERM	M	1600	0	1600		7	4.0	0.0	4.0	1510	24.50	26.00	12.75	17.5	-
N	22	Van Steirteghem, Eliott	67	68	ULB Owls	M	0	0	0		7	4.0	0.0	4.0	1355	23.50	25.50	11.50	18.0	-
N	23	Abrahams, Sander	14	21	KU Leuven	M	1600	0	1600		7	4.0	0.0	4.0	1364	23.50	24.00	9.50	15.0	-
N	24	Arakelyan, Narek	30	29	UAntwerpen	M	1350	0	1350		7	4.0	0.0	4.0	1220	23.00	26.00	12.00	15.0	-
N	25	Bruyland, Simeon	52	60	UGent	M	0	0	0		7	4.0	0.0	4.0	1312	23.00	25.50	12.00	16.0	-
	26	Coenen, Jonah	17	40	KU Leuven	M	0	0	0		7	4.0	0.0	4.0	1028	22.50	23.50	11.75	14.5	-

F	#	Name Firstname	Nr	Rnk	Institute	M/V	Elo	Fide	EloUsed	Title	Games	Pts	XtPts	P.Tot.	Perf	B Cut1	Buch	S.B.	Prog.	DirEn
N	27	Langlet, Maxime	65	67	ULB Owls	M	0	0	0		6	4.0	0.0	4.0	650	17.00	19.00	10.00	11.0	-
N	28	Nazarov, Kirill	71	71	ULB Owls	M	0	0	0		6	3.5	0.0	3.5	1258	26.00	29.00	13.25	16.5	-
N	29	Standaert, Matias	50	59	UCLouvain Wolves	M	0	0	0		6	3.5	0.0	3.5	1548	25.50	27.50	11.50	15.5	-
N	30	van Betsbrugge, Ewout	22	42	KU Leuven	M	0	0	0		7	3.5	0.0	3.5	1137	24.00	26.50	11.25	13.5	-
N	31	Rabah, Ahmad	15	10	KU Leuven	M	1800	0	1800		7	3.5	0.0	3.5	1479	21.50	23.50	9.00	13.5	-
N	32	Meersman, Nicolas	24	25	KU Leuven KULAK	M	1500	0	1500		7	3.5	0.0	3.5	1314	20.50	23.00	9.25	13.5	-
N	33	Gottfried, Simon	28	45	Thomas More	M	0	0	0		7	3.0	0.0	3.0	907	24.50	25.00	6.50	12.0	-
N	34	Beerlandt, Jules	23	22	KU Leuven KULAK	M	1600	0	1600		7	3.0	0.0	3.0	1264	24.00	26.00	7.00	15.0	-
N	35	Guillaume, Félix	44	53	UCLouvain Wolves	M	0	0	0		6	3.0	0.0	3.0	742	23.00	24.50	7.50	11.0	-
N	36	Oud, Ruben	6	34	ERM	M	1100	0	1100		7	3.0	0.0	3.0	879	22.00	23.50	6.50	12.0	-
N	37	Hoet, Nathan	45	54	UCLouvain Wolves	M	0	0	0		7	3.0	0.0	3.0	1410	21.00	22.50	5.50	13.0	-
	38	De Praitere, Hannes	19	41	KU Leuven	M	0	0	0		7	3.0	0.0	3.0	453	21.00	21.50	4.00	10.0	-
N	39	Lotfi, Ayoub	31	46	UAntwerpen	M	0	0	0		7	3.0	0.0	3.0	1179	20.50	22.00	7.50	11.0	-
N	40	Topolaj, Evis	29	30	Thomas More	M	1200	0	1200		6	3.0	0.0	3.0	816	20.50	22.00	7.00	12.0	-
N	41	Dietvorst, Seppe	4	36	ERM	M	0	0	0		7	3.0	0.0	3.0	406	20.50	22.00	5.00	10.0	-
N	42	Gombosuren, Kristina	69	69	VIVES	V	0	0	0		7	3.0	0.0	3.0	852	20.00	21.50	7.50	12.0	-
N	43	Wuyts, Seppe	35	48	UAntwerpen	M	0	0	0		7	3.0	0.0	3.0	1063	19.00	21.00	6.50	12.0	-
N	44	Smis, Gavroche	3	33	Artevelde	M	1100	0	1100		7	3.0	0.0	3.0	650	17.50	18.50	5.50	9.0	-
N	45	Heylen, Noah	11	39	HOGENT	M	0	0	0		7	2.5	0.0	2.5	903	23.00	24.00	5.50	10.0	0.5
N	46	Cailteux,Thomas	38	50	UCLouvain Wolves	M	0	0	0		6	2.5	0.0	2.5	741	17.00	17.50	2.75	8.0	0.5
N	47	Verbist, Gijs	2	31	AP	M	1150	0	1150		7	2.0	0.0	2.0	706	22.50	23.50	6.00	11.0	-
N	48	Acke, Pierre	26	43	Odisee	M	0	0	0		5	2.0	0.0	2.0	1072	22.00	24.00	4.50	10.0	-
N	49	Bellégou, Glenn	36	49	UCLL Leuven	M	0	0	0		7	2.0	0.0	2.0	734	22.00	22.50	5.00	9.0	-
N	50	de Condé, Léopold	42	51	UCLouvain Wolves	M	0	0	0		6	2.0	0.0	2.0	593	20.50	22.00	4.50	7.0	-
N	51	Potters, Dominic	32	47	UAntwerpen	M	0	0	0		6	2.0	0.0	2.0	508	19.50	20.50	2.00	6.0	-
N	52	De Beenhouwer, Therenty	18	12	KU Leuven	M	1750	0	1750		7	2.0	0.0	2.0	1256	19.00	19.50	3.50	6.0	-
N	53	Servais, Arnaud	49	58	UCLouvain Wolves	M	0	0	0		6	2.0	0.0	2.0	691	18.50	20.50	5.00	8.0	-
N	54	Lips, Renaud	59	65	UHasselt	M	0	0	0		5	2.0	0.0	2.0	-400	17.50	19.00	3.00	6.0	-
N	55	Kiekens, Thomas	46	55	UCLouvain Wolves	M	0	0	0		6	2.0	0.0	2.0	610	16.00	16.50	1.50	3.0	-
N	56	Merveille, Lander	12	35	Howest	M	1100	0	1100		7	1.5	0.0	1.5	594	22.50	23.50	2.50	4.5	-
N	57	Pire, Victor	66	27	ULB Owls	M	1500	0	1500		5	1.0	0.0	1.0	1010	17.50	18.50	1.50	3.0	-
N	58	Schmit, Manon	48	57	UCLouvain Wolves	V	0	0	0		6	1.0	0.0	1.0	-242	17.00	18.00	1.00	3.0	-
N	59	Godochian, George	43	52	UCLouvain Wolves	M	0	0	0		7	1.0	0.0	1.0	631	15.50	17.00	2.00	4.0	-



# BSK Schaken / FSUB Echecs 2021-22

## Results

22/2/2022 - Hof van Liere, University of Antwerp (Belgium)

Referee: Patrick Van de Perre

Pace: 15'+0"

### ROUND 1

Table	White	Points	N-Elo	Result	Black	Points	N-Elo
1	Van Dijck, Bjarne	0.0	2112	1-0	Oud, Ruben	0.0	1100
2	Merveille, Lander	0.0	1100	0-1	De Block, Yordi	0.0	2090
3	Dallemagne, Maximilien	0.0	2089	1-0	Dietvorst, Seppe	0.0	0
4	Heylen, Noah	0.0	0	0-1	Butzen, Robin	0.0	2016
5	Vernimmen, Pierre	0.0	1978	1-0	Coenen, Jonah	0.0	0
6	De Praitere, Hannes	0.0	0	0-1	Rotaru, Teodor	0.0	1922
7	Coucke, Yari	0.0	1900	1-0	van Betsbrugge, Ewout	0.0	0
8	Gottfried, Simon	0.0	0	0-1	Aguilar, Adriano	0.0	1823
9	Rabah, Ahmad	0.0	1800	½-½	Lotfi, Ayoub	0.0	0
10	Potters, Dominic	0.0	0	0-1	Aguilar, Luciano	0.0	1770
11	De Beenhouwer, Theren	0.0	1750	0-1	Wuyts, Seppe	0.0	0
12	Bellégou, Glenn	0.0	0	1-0	Burignat, Yohan	0.0	1718
13	De Baets, Keano	0.0	1690	1-0	Cailteux,Thomas	0.0	0
14	de Condé, Léopold	0.0	0	0-1	Rousseau, Christilla	0.0	1662
15	De Briey, Aurian	0.0	1637	1-0	Godochian, George	0.0	0
16	Guillaume, Félix	0.0	0	0-1	Lascar, Radoslaw	0.0	1636
17	Dallemagne, Briec	0.0	1633	1-0	Hoet, Nathan	0.0	0
18	Kiekens, Thomas	0.0	0	0-1	Rössler, Christian	0.0	1600
19	Abrahams, Sander	0.0	1600	1-0	Schmit, Manon	0.0	0
20	Servais, Arnaud	0.0	0	0-1	Beerlandt, Jules	0.0	1600
21	Denis, Romain	0.0	1600	½-½	Standaert, Matias	0.0	0
22	Bruyland, Simeon	0.0	0	1-0	Meersman, Nicolas	0.0	1500
23	Pire, Victor	0.0	1500	0-1	Debaere Thomas	0.0	0
24	Lips, Renaud	0.0	0	0-1	Pouliart, Sander	0.0	1383
25	Arakelyan, Narek	0.0	1350	0-1	Carati, Félix	0.0	0
26	Langlet, Maxime	0.0	0	0-1	Topolaj, Evis	0.0	1200
27	Verbist, Gijs	0.0	1150	0-1	Van Steirteghem, Eliott	0.0	0
28	Gombosuren, Kristina	0.0	0	1-0	Smis, Gavroche	0.0	1100
	Nazarov, Kirill	0.0	0		1 Bye		
	Acke, Pierre	0.0	0		0 Absent		
	Deneuille, walter	1.0	1700		0 Absent		

### ROUND 2

Table	White	Points	N-Elo	Result	Black	Points	N-Elo
1	Rössler, Christian	1.0	1600	½-½	Van Dijck, Bjarne	1.0	2112
2	De Block, Yordi	1.0	2090	1-0	Abrahams, Sander	1.0	1600
3	Beerlandt, Jules	1.0	1600	0-1	Dallemagne, Maximilien	1.0	2089
4	Pouliart, Sander	1.0	1383	1-0	Vernimmen, Pierre	1.0	1978
5	Rotaru, Teodor	1.0	1922	1-0	Heylen, Noah	0.0	0
6	Topolaj, Evis	1.0	1200	0-1	Coucke, Yari	1.0	1900
7	Aguilar, Adriano	1.0	1823	1-0	Bellégou, Glenn	1.0	0
8	Aguilar, Luciano	1.0	1770	1-0	Bruyland, Simeon	1.0	0
9	Wuyts, Seppe	1.0	0	0-1	De Baets, Keano	1.0	1690
10	Rousseau, Christilla	1.0	1662	1-0	Gombosuren, Kristina	1.0	0
11	Debaere Thomas	1.0	0	0-1	De Briey, Aurian	1.0	1637
12	Lascar, Radoslaw	1.0	1636	1-0	Nazarov, Kirill	1.0	0
13	Carati, Félix	1.0	0	0-1	Dallemagne, Briec	1.0	1633
14	Van Steirteghem, Eliott	1.0	0	1-0	Rabah, Ahmad	0.5	1800

15	Lotfi, Ayoub	0.5	0	0-1	Denis, Romain	0.5	1600
16	Standaert, Matias	0.5	0	1-0	De Beenhouwer, Theren	0.0	1750
17	Butzen, Robin	1.0	2016	1-0	Gottfried, Simon	0.0	0
18	Burignat, Yohan	0.0	1718	1-0	Potters, Dominic	0.0	0
19	Meersman, Nicolas	0.0	1500	1-0	de Condé, Léopold	0.0	0
20	Acke, Pierre	0.0	0	1-0	Pire, Victor	0.0	1500
21	Cailteux,Thomas	0.0	0	0-1	Arakelyan, Narek	0.0	1350
22	Godochian, George	0.0	0	0-1	Verbist, Gijs	0.0	1150
23	Smis, Gavroche	0.0	1100	0-1	Guillaume, Félix	0.0	0
24	Oud, Ruben	0.0	1100	1-0	Kiekens, Thomas	0.0	0
25	Hoet, Nathan	0.0	0	1-0	Merveille, Lander	0.0	1100
26	Dietvorst, Seppe	0.0	0	0-1	Servais, Arnaud	0.0	0
27	Coenen, Jonah	0.0	0	1-0	Lips, Reinaud	0.0	0
28	Schmit, Manon	0.0	0	0-1	De Praitere, Hannes	0.0	0
29	van Betsbrugge, Ewout	0.0	0	1-0	Langlet, Maxime	0.0	0
	Bundotich, Brian	0.0	0	0	Absent		
	Demey, Lotte	0.0	1561	0	Absent		
	Deneuille, walter	1.0	1700	0	Absent		
	Friedman, Shneor	0.0	1150	0	Absent		
	Ryelandt, Bastien	0.0	0	0	Absent		
	Peeters, Ruben	0.0	0	0	Absent		
	Van Neer, Seppe	0.0	0	0	Absent		
	De Vleeschauwer, Maart	0.0	2158	0	Absent		
	Stemans, Marnix	0.0	0	0	Absent		
	Raj, Karki	0.0	0	0	Absent		
	Boreux, Nathalie	0.0	0	0	Forfeit		
	Dekeukeleire, Lennard	0.0	1500	0	Forfeit		
	Mussche, Thiemen	0.0	0	0	Forfeit		

### ROUND 3

Table	White	Points	N-Elo	Result	Black	Points	N-Elo
1	De Baets, Keano	2.0	1690	0-1	De Block, Yordi	2.0	2090
2	Dallemagne, Maximilien	2.0	2089	1-0	Rousseau, Christilla	2.0	1662
3	De Briey, Aurian	2.0	1637	½-½	Butzen, Robin	2.0	2016
4	Lascar, Radoslaw	2.0	1636	1-0	Rotaru, Teodor	2.0	1922
5	Coucke, Yari	2.0	1900	1-0	Pouliart, Sander	2.0	1383
6	Dallemagne, Briec	2.0	1633	0-1	Aguilar, Adriano	2.0	1823
7	Van Steirteghem, Eliott	2.0	0	0-1	Aguilar, Luciano	2.0	1770
8	Van Dijck, Bjarne	1.5	2112	1-0	Standaert, Matias	1.5	0
9	Denis, Romain	1.5	1600	1-0	Rössler, Christian	1.5	1600
10	Vernimmen, Pierre	1.0	1978	1-0	van Betsbrugge, Ewout	1.0	0
11	Guillaume, Félix	1.0	0	0-1	Burignat, Yohan	1.0	1718
12	Deneuille, walter	1.0	1700	1-0	Acke, Pierre	1.0	0
13	Abrahams, Sander	1.0	1600	1-0	Wuyts, Seppe	1.0	0
14	Bellégou, Glenn	1.0	0	0-1	Beerlandt, Jules	1.0	1600
15	Servais, Arnaud	1.0	0	0-1	Meersman, Nicolas	1.0	1500
16	Arakelyan, Narek	1.0	1350	1-0	Hoet, Nathan	1.0	0
17	Bruyland, Simeon	1.0	0	1-0	Topolaj, Evis	1.0	1200
18	Verbist, Gijs	1.0	1150	1-0	Debaere Thomas	1.0	0
19	Gombosuren, Kristina	1.0	0	0-1	Oud, Ruben	1.0	1100
20	Nazarov, Kirill	1.0	0	1-0	Coenen, Jonah	1.0	0
21	De Praitere, Hannes	1.0	0	0-1	Carati, Félix	1.0	0
22	Rabah, Ahmad	0.5	1800	1-0	Pire, Victor	0.0	1500
23	Merveille, Lander	0.0	1100	½-½	Lotfi, Ayoub	0.5	0
24	De Beenhouwer, Theren	0.0	1750	1-0	Cailteux,Thomas	0.0	0
25	de Condé, Léopold	0.0	0	1-0	Smis, Gavroche	0.0	1100
26	Kiekens, Thomas	0.0	0	0-1	Dietvorst, Seppe	0.0	0
27	Heylen, Noah	0.0	0	1-0	Godochian, George	0.0	0
28	Gottfried, Simon	0.0	0	1-0	Schmit, Manon	0.0	0
29	Potters, Dominic	0.0	0	1-0	Lips, Reinaud	0.0	0
	Langlet, Maxime	0.0	0		1 Bye		

### ROUND 4

Table	White	Points	N-Elo	Result	Black	Points	N-Elo
1	De Block, Yordi	3.0	2090	1-0	Lascar, Radoslaw	3.0	1636
2	Aguilar, Adriano	3.0	1823	0-1	Dallemagne, Maximilien	3.0	2089
3	Aguilar, Luciano	3.0	1770	1-0	Coucke, Yari	3.0	1900
4	De Briey, Aurian	2.5	1637	0-1	Van Dijck, Bjarne	2.5	2112
5	Butzen, Robin	2.5	2016	1-0	Denis, Romain	2.5	1600
6	Meersman, Nicolas	2.0	1500	0-1	Vernimmen, Pierre	2.0	1978
7	Rotaru, Teodor	2.0	1922	1-0	Arakelyan, Narek	2.0	1350
8	Burignat, Yohan	2.0	1718	1-0	Verbist, Gijs	2.0	1150
9	Pouliart, Sander	2.0	1383	0-1	Deneuille, walter	2.0	1700
10	Oud, Ruben	2.0	1100	0-1	De Baets, Keano	2.0	1690
11	Rousseau, Christilla	2.0	1662	1-0	Bruyland, Simeon	2.0	0
12	Nazarov, Kirill	2.0	0	½-½	Dallemagne, Brieuc	2.0	1633
13	Carati, Félix	2.0	0	1-0	Abrahams, Sander	2.0	1600
14	Beerlandt, Jules	2.0	1600	0-1	Van Steirteghem, Eliott	2.0	0
15	Standaert, Matias	1.5	0	1-0	Rabah, Ahmad	1.5	1800
16	Rössler, Christian	1.5	1600	1-0	De Praitere, Hannes	1.0	0
17	Hoet, Nathan	1.0	0	1-0	De Beenhouwer, Theren	1.0	1750
18	Topolaj, Evis	1.0	1200	1-0	Potters, Dominic	1.0	0
19	Dietvorst, Seppe	1.0	0	1-0	Bellégou, Glenn	1.0	0
20	Wuyts, Seppe	1.0	0	0-1	Heylen, Noah	1.0	0
21	Coenen, Jonah	1.0	0	1-0	de Condé, Léopold	1.0	0
22	van Betsbrugge, Ewout	1.0	0	1-0	Guillaume, Félix	1.0	0
23	Acke, Pierre	1.0	0	1-0	Servais, Arnaud	1.0	0
24	Langlet, Maxime	1.0	0	0-1	Gottfried, Simon	1.0	0
25	Lotfi, Ayoub	1.0	0	1-0	Gombosuren, Kristina	1.0	0
26	Debaere Thomas	1.0	0	1-0	Merveille, Lander	0.5	1100
27	Pire, Victor	0.0	1500	0-1	Godochian, George	0.0	0
28	Smis, Gavroche	0.0	1100	1-0	Kiekens, Thomas	0.0	0
29	Cailteux, Thomas	0.0	0	1-0	Schmit, Manon	0.0	0
	Lips, Renaud	0.0	0		1 Bye		

### ROUND 5

Table	White	Points	N-Elo	Result	Black	Points	N-Elo
1	Dallemagne, Maximilien	4.0	2089	½-½	De Block, Yordi	4.0	2090
2	Van Dijck, Bjarne	3.5	2112	½-½	Aguilar, Luciano	4.0	1770
3	Vernimmen, Pierre	3.0	1978	1-0	Butzen, Robin	3.5	2016
4	De Baets, Keano	3.0	1690	0-1	Rotaru, Teodor	3.0	1922
5	Coucke, Yari	3.0	1900	1-0	Rousseau, Christilla	3.0	1662
6	Lascar, Radoslaw	3.0	1636	0-1	Aguilar, Adriano	3.0	1823
7	Van Steirteghem, Eliott	3.0	0	0-1	Burignat, Yohan	3.0	1718
8	Deneuille, walter	3.0	1700	1-0	Carati, Félix	3.0	0
9	Denis, Romain	2.5	1600	½-½	De Briey, Aurian	2.5	1637
10	Dallemagne, Brieuc	2.5	1633	1-0	Standaert, Matias	2.5	0
11	Rössler, Christian	2.5	1600	½-½	Nazarov, Kirill	2.5	0
12	Abrahams, Sander	2.0	1600	0-1	Coenen, Jonah	2.0	0
13	Heylen, Noah	2.0	0	0-1	Beerlandt, Jules	2.0	1600
14	van Betsbrugge, Ewout	2.0	0	½-½	Meersman, Nicolas	2.0	1500
15	Pouliart, Sander	2.0	1383	1-0	Acke, Pierre	2.0	0
16	Arakelyan, Narek	2.0	1350	1-0	Lotfi, Ayoub	2.0	0
17	Gottfried, Simon	2.0	0	1-0	Topolaj, Evis	2.0	1200
18	Verbist, Gijs	2.0	1150	0-1	Hoet, Nathan	2.0	0
19	Bruyland, Simeon	2.0	0	1-0	Oud, Ruben	2.0	1100
20	Debaere Thomas	2.0	0	1-0	Dietvorst, Seppe	2.0	0
21	Rabah, Ahmad	1.5	1800	1-0	De Beenhouwer, Theren	1.0	1750
22	Godochian, George	1.0	0	0-1	Smis, Gavroche	1.0	1100
23	De Praitere, Hannes	1.0	0	1-0	de Condé, Léopold	1.0	0
24	Potters, Dominic	1.0	0	0-1	Guillaume, Félix	1.0	0
25	Servais, Arnaud	1.0	0	0-1	Wuyts, Seppe	1.0	0
26	Bellégou, Glenn	1.0	0	0-1	Langlet, Maxime	1.0	0
27	Lips, Renaud	1.0	0	0-1	Cailteux, Thomas	1.0	0
28	Gombosuren, Kristina	1.0	0	1-0	Merveille, Lander	0.5	1100
29	Kiekens, Thomas	0.0	0	0-1	Pire, Victor	0.0	1500

Schmit, Manon 0.0 0 1 Bye

### ROUND 6

Table	White	Points	N-Elo	Result	Black	Points	N-Elo
1	Aguilar, Luciano	4.5	1770	0-1	Dallemagne, Maximilien	4.5	2089
2	De Block, Yordi	4.5	2090	½-½	Coucke, Yari	4.0	1900
3	Aguilar, Adriano	4.0	1823	0-1	Van Dijck, Bjarne	4.0	2112
4	Burignat, Yohan	4.0	1718	½-½	Vernimmen, Pierre	4.0	1978
5	Rotaru, Teodor	4.0	1922	1-0	Deneuille, walter	4.0	1700
6	Butzen, Robin	3.5	2016	1-0	Dallemagne, Brieuç	3.5	1633
7	Arakelyan, Narek	3.0	1350	0-1	De Baets, Keano	3.0	1690
8	Rousseau, Christilla	3.0	1662	1-0	Gottfried, Simon	3.0	0
9	Coenen, Jonah	3.0	0	½-½	De Briey, Aurian	3.0	1637
10	Hoet, Nathan	3.0	0	0-1	Lascar, Radoslawa	3.0	1636
11	Bruyland, Simeon	3.0	0	0-1	Rössler, Christian	3.0	1600
12	Beerlandt, Jules	3.0	1600	0-1	Debaere Thomas	3.0	0
13	Carati, Félix	3.0	0	1-0	Denis, Romain	3.0	1600
14	Nazarov, Kirill	3.0	0	½-½	Pouliart, Sander	3.0	1383
15	Standaert, Matias	2.5	0	1-0	Van Steirteghem, Eliott	3.0	0
16	Meersman, Nicolas	2.5	1500	0-1	Rabah, Ahmad	2.5	1800
17	Topolaj, Evis	2.0	1200	0-1	van Betsbrugge, Ewout	2.5	0
18	Lotfi, Ayoub	2.0	0	0-1	Abrahams, Sander	2.0	1600
19	Wuyts, Seppe	2.0	0	1-0	Verbist, Gijs	2.0	1150
20	Smis, Gavroche	2.0	1100	1-0	Acke, Pierre	2.0	0
21	Oud, Ruben	2.0	1100	0-1	Langlet, Maxime	2.0	0
22	Dietvorst, Seppe	2.0	0	0-1	Gombosuren, Kristina	2.0	0
23	Cailteux, Thomas	2.0	0	½-½	Heylen, Noah	2.0	0
24	Guillaume, Félix	2.0	0	1-0	De Praitere, Hannes	2.0	0
25	De Beenhouwer, Theren	1.0	1750	0-1	Servais, Arnaud	1.0	0
26	Pire, Victor	1.0	1500	0-1ff	Lips, Reinaud	1.0	0
27	de Condé, Léopold	1.0	0	1-0	Potters, Dominic	1.0	0
28	Schmit, Manon	1.0	0	0-1	Bellégou, Glenn	1.0	0
29	Merveille, Lander	0.5	1100	1-0	Godochian, George	1.0	0
	Kiekens, Thomas	0.0	0		1 Bye		

### ROUND 7

Table	White	Points	N-Elo	Result	Black	Points	N-Elo
1	Dallemagne, Maximilien	5.5	2089	1-0	Rotaru, Teodor	5.0	1922
2	Van Dijck, Bjarne	5.0	2112	½-½	De Block, Yordi	5.0	2090
3	Coucke, Yari	4.5	1900	0-1	Butzen, Robin	4.5	2016
4	Vernimmen, Pierre	4.5	1978	0-1	Aguilar, Luciano	4.5	1770
5	Deneuille, walter	4.0	1700	1-0	Burignat, Yohan	4.5	1718
6	Rössler, Christian	4.0	1600	0-1	Aguilar, Adriano	4.0	1823
7	De Baets, Keano	4.0	1690	0-1	Carati, Félix	4.0	0
8	Lascar, Radoslawa	4.0	1636	1-0	Rousseau, Christilla	4.0	1662
9	Rabah, Ahmad	3.5	1800	0-1	Debaere Thomas	4.0	0
10	De Briey, Aurian	3.5	1637	1-0	Nazarov, Kirill	3.5	0
11	Dallemagne, Brieuç	3.5	1633	½-½	Coenen, Jonah	3.5	0
12	Pouliart, Sander	3.5	1383	1-0	van Betsbrugge, Ewout	3.5	0
13	Abrahams, Sander	3.0	1600	1-0	Hoet, Nathan	3.0	0
14	Langlet, Maxime	3.0	0	1-0	Beerlandt, Jules	3.0	1600
15	Denis, Romain	3.0	1600	1-0	Wuyts, Seppe	3.0	0
16	Gombosuren, Kristina	3.0	0	0-1	Arakelyan, Narek	3.0	1350
17	Van Steirteghem, Eliott	3.0	0	1-0	Smis, Gavroche	3.0	1100
18	Gottfried, Simon	3.0	0	0-1	Bruyland, Simeon	3.0	0
19	Heylen, Noah	2.5	0	0-1	Meersman, Nicolas	2.5	1500
20	Acke, Pierre	2.0	0	0-1ff	Topolaj, Evis	2.0	1200
21	Verbist, Gijs	2.0	1150	0-1	Lotfi, Ayoub	2.0	0
22	Bellégou, Glenn	2.0	0	0-1	Oud, Ruben	2.0	1100
23	De Praitere, Hannes	2.0	0	1-0	Lips, Reinaud	2.0	0
24	Merveille, Lander	1.5	1100	0-1	Dietvorst, Seppe	2.0	0
25	Schmit, Manon	1.0	0	0-1	De Beenhouwer, Theren	1.0	1750
26	Godochian, George	1.0	0	0-1	Kiekens, Thomas	1.0	0

Potters, Dominic	1.0	0	1 Bye
Cailteux,Thomas	2.5	0	0 Absent
Servais, Arnaud	2.0	0	0 Absent
Standaert, Matias	3.5	0	0 Absent
Guillaume, Félix	3.0	0	0 Absent
de Condé, Léopold	2.0	0	0 Absent
Pire, Victor	1.0	1500	0 Absent



# Résultats du Championnat FSUB d'Escrime

Club des « 3 armes » à Gembloux

Salle des Sports de l'Ecole Horticole

Samedi 13 février 2022

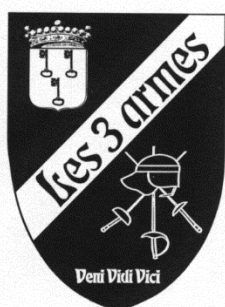

## Résultats du championnat FSUB d'Esime Dimanche 13 février 2022 à Gembloux

### Epée Hommes

#### Overall ranking

Rank		Club	Nation
1)	PONCIN Nicolas	UCL	
2)	HABRAN Maxime	UCL	
3)	APERS Matthew	K.U. LEUVEN	
4)	COUNSON François	U.LIEGE	
5)	HAMOLINE Gautier	UCL	
6)	SANZ Leandro	U.LIEGE	
7)	FELTZ Maxim	HENALUX	
8)	CLERX Robin	ARTEVELDEHOGESCHOOL	
9)	JANSSENS William	UNIV.GENT	
10)	ROCKMANS Baptiste	CONDORCET	
11)	DUPAS Jean Gauthier	UNIV.NAMUR	
12)	POCKELE Joris	UNIV.GENT	
13)	VANHASSEL André	KAREL DE GROTE HOGES.	
14)	DUVERGER Jerome	ERM KMS	
15)	BOITTE Loik	UNIV.MONS	
16)	CORVERS Mathis	U.LIEGE	
17)	ABADJENE Kossi	UNIV.MONS	
18)	VAN QUATHEN Simon	U ANTWERPEN	
19)	GOULARD Pierre	U.LIEGE	
20)	BRACKE Michael	UNIV.GENT	
21)	GALET Maxime	U.LIEGE	
22)	VAN QUATHEN Mathias	U ANTWERPEN	
23)	CORDIER Brice	UNIV.MONS	
24)	SCHUERMAN Aaron	U ANTWERPEN	
25)	ERNOTTE Sylvain	UNIV.NAMUR	
26)	GAST Aldrin	U ANTWERPEN	
27)	PIERLOT Alexandre	UCL	
28)	DALLEMAGNE Louis	HENALUX	
29)	MARICHAL Gaëtan	ERM KMS	
30)	GHISLAIN Maxime	ERM KMS	
31)	TENAERTS François Xa.	HE PROVINCELIÈGE	
32)	LAPON Stijn	ERM KMS	
33)	ELST Anton	ERM KMS	
34)	WOUTERS Tim	ERM KMS	
35)	GARBAR Alexandre	UNIV.NAMUR	
36)	DE BECKER Quentin	ERM KMS	

### Epée Dames

#### Overall ranking

Rank		Club	Nation
1)	SALOMON Laure	HEPL	
2)	VANDEBOSSCHE Clara	UNIV.NAMUR	
3)	DE LANDTSHEER Ellen	U GENT	
4)	KUZMOVA Miroslava	UCL	
5)	STEURBAUT Romane	HOGESCHOOL GENT	
6)	COLINET Lucie	U.LIÈGE	
7)	LEJEUNE Elise	HAUTE ECOLE PROVLIE.	
8)	JANSSEN Hannelore	ODISEE HOGESSCHOOL	
9)	SCHRODER Anne	HTE ECOLE LEONARD DE.	
10)	MEERT Zoé	ERM KMS	
11)	LELEU Margaux	UNIV.NAMUR	

Tous les résultats disponibles sur :

<https://engarde-service.com/app.php?id=2110v4>

### Sabre Hommes

#### Overall ranking

Rank		Club	Nation
1)	JACQUES Philippe	U.C.LOUVAIN	
2)	PROSSE Maël	HOGESCHOOL WESYVLAN.	
3)	POIZAT Alexandre	UNIV.LIEGE	
4)	LEGRAND Gauthier	U.C.LOUVAIN	
5)	THIELEMANS Alain	V U BRUSSEL	
6)	DE VOLDER Martin	UNIV.NAMUR	

### Sabre Dames

#### Overall ranking

Rank		Club	Nation
1)	FONDEUR Apolline	U.C.LOUVAIN	
2)	DERDE Héléne	UNIV GENT	
3)	THIELEN Isabelle	K.U.LEUVEN	
4)	PONCIN Auriane	UNIV.LIÈGE	
5)	POIZAT Juliette	HEPL	









## Fleuret Hommes

### Overall ranking

Rank		Club	Nation
1)	DE GREEF Stef	VRIJE UNIV.BRUSSEL	
2)	NAVAS Timothy	UNIV.NAMUR	
3)	NIJS Mathieu	U.L.BRUXELLES	
4)	HONET Antoine	UNIV.NAMUR	
5)	VERSTEVEN Zeger	ERM KMS	
6)	VAN GERVEN Jasper	K.U.LEUVEN	
7)	DUPONT Clément	UNIV.NAMUR	
8)	KLOECK Arend	K.U.LEUVEN	
9)	COPPIETERS Thomas	UCL	
10)	LAGUNA AGUIRREZ Vinc.	UCL	
11)	LEJOLY Simon	UNIV.NAMUR	
12)	BENNINGTON David	UCL	
13)	GAILLY Sébastien	UNIV.NAMUR	

## Fleuret Dames

### Overall ranking

Rank		Club	Nation
1)	JORDENS Héloïse	UNIV.NAMUR	
2)	DRYBOOMS Manon	UNIV.NAMUR	
3)	DON Laura	KU LEUVEN	
4)	SWENNEN Annemaine	HOGESCHOOL PXL	
5)	SION Marie	U.C.L	
6)	WAUTERS Marjolein	KU LEUVEN	
7)	COLIGNON Marie	U.C.L	
8)	GOHIER Emérance	U.C.L	

# Résultats du Championnat FSUB de Floorball

Complexe Sportif de l'Orneau  
(Gembloux)

Mercredi 9 mars 2022





## Floorball : Saison 2021-2022

Championnat FSUB

Dernière mise à jour: 10/03/2022

### Poule A

#### Equipes

1	AUGent
2	UCLouvain Wolves
3	HENALLUX

N° Match	Tournoi: Complexe sportif de l'Orneau, Chaussée de Namur 28-5030 Gembloux				Résultat		Forfait
	Horaire	Date	Visités	Visiteurs	Home	Visi	
1	19:15	Mercredi 9 mars 2022	UCLouvain Wolves	HENALLUX	10	0	
2	19:45	Mercredi 9 mars 2022	HENALLUX	AUGent	1	11	
3	20:15	Mercredi 9 mars 2022	AUGent	UCLouvain Wolves	6	3	
4	21:15	Mercredi 9 mars 2022	HENALLUX	UCLouvain Wolves	1	7	
5	21:45	Mercredi 9 mars 2022	AUGent	HENALLUX	10	2	
6	22:15	Mercredi 9 mars 2022	UCLouvain Wolves	AUGent	4	6	

### Classement

Equipe	Joué	Gagné	Perdu	Nul	BP	BC	Diff	Pts	CL
AUGent	4	4	0	0	33	10	23	12	1
UCLouvain Wolves	4	2	2	0	24	13	11	6	2
HENALLUX	4	0	4	0	4	38	-34	0	3

### Règlement

Durée: 1 x 20 minutes

Un temps mort est autorisé par équipe et par match

# Résultats du Championnat FSUB de Gymnastique

BLOCRY – UCLouvain

Lundi 28 mars 2022



## Classement individuel GAF : Championnat FSUB de Gymnastique 28 mars 2022

GAF								
Dos	Nom	Unif	Saut	Barres	Poutre	Sol	Total	Classement
16	Kohnenmergen Emma	HEVinci indiv	11,850	10,867	14,450	12,933	50,10	1
13	Charlotte Simon	UCLouvain 2	11,800	10,467	11,050	11,933	45,25	2
27	Neyrinck Margot	KULeuven	11,750	9,700	10,700	12,133	44,28	3
2	Dumont Elise	UCLouvain 1	11,800	8,567	11,150	12,467	43,98	4
21	Leyder Juliette	HEVinci	11,500	10,200	9,550	12,167	43,42	5
14	Van Caenegem Elise	UCLouvain 2	11,950	9,900	10,850	10,667	43,37	6
5	Tasiaux Laurine	UCLouvain 1	11,300	9,467	11,050	11,400	43,22	7
4	Renders Wendy	UCLouvain 1	11,050	7,767	11,750	12,333	42,90	8
24	Harschène Sophie	Henallux	10,900	8,400	10,750	9,633	39,68	9
22	Tavernier Lola	HEVinci	10,750	9,800	8,150	10,833	39,53	10
30	Aerts Lois	KULeuven	10,950	8,000	10,100	10,233	39,28	11
29	Van Deyck Meredith	KULeuven	11,200	5,267	11,300	10,500	38,27	12
9	Back Natalia	UCLouvain 2	10,750	7,200	8,200	11,267	37,42	13
17	Van Caenegem Maëlle	UCLouvain indiv	9,750	8,400	8,700	10,300	37,15	14
20	Jadot Emilie	HEVinci	10,100	6,833	10,000	9,567	36,50	15
31	Aerts Mia	KULeuven	10,900	7,533	8,250	9,600	36,28	16
18	Bruyeer Sabine	HEVinci	11,500	7,000	6,800	10,200	35,50	17
3	Gronemberger Eléa	UCLouvain 1	11,350	10,567		10,867	32,78	18
26	Lecomte Adélaïde	KULeuven	10,450	2,633	8,250	10,133	31,47	19
1	Dochy Juliette	UCLouvain 1		9,133	10,350	11,333	30,82	20
10	Crefcoeur Leslie	UCLouvain 2	11,450	7,167		9,700	28,32	21
25	Vincart Chloé	Henallux	10,650	1,000	4,550	9,167	25,37	22
12	Renaud Laura	UCLouvain 2		9,867	10,550		20,42	23
15	Wiseur Romane	UCLouvain 2			9,350	10,933	20,28	24
23	Vlaemynck Léa	HEVinci	9,800			10,400	20,20	25
11	Geortay Julie	UCLouvain 2			7,800	10,967	18,77	26
19	Delange Laura	HEVinci					0,00	NC
28	VandenBroucke Hanne	KULeuven					0,00	NC

## Classement individuel GAF par agrès : Championnat FSUB de Gymnastique 28 mars 2022

### GAF par Agrès

Dos	Nom	Unif	Saut
14	Van Caenegem Elise	UCLouvain 2	11,950
16	Kohnenmergen Emma	HEVinci indiv	11,850
2	Dumont Elise	UCLouvain 1	11,800
13	Charlotte Simon	UCLouvain 2	11,800
27	Neyrinck Margot	KULeuven	11,750
18	Bruyeer Sabine	HEVinci	11,500
21	Leyder Juliette	HEVinci	11,500
10	Crefcoeur Leslie	UCLouvain 2	11,450
3	Gronemberger Eléa	UCLouvain 1	11,350
5	Tasiaux Laurine	UCLouvain 1	11,300
29	Van Deyck Meredith	KULeuven	11,200
4	Renders Wendy	UCLouvain 1	11,050
30	Aerts Lois	KULeuven	10,950
24	Harschène Sophie	Henallux	10,900
31	Aerts Mia	KULeuven	10,900
9	Back Natalia	UCLouvain 2	10,750
22	Tavernier Lola	HEVinci	10,750
25	Vincart Chloé	Henallux	10,650
26	Lecomte Adélaïde	KULeuven	10,450
20	Jadot Emilie	HEVinci	10,100
23	Vlaemynck Léa	HEVinci	9,800
17	Van Caenegem Maëlle	UCLouvain indiv	9,750
1	Dochy Juliette	UCLouvain 1	0,000
6	Gendebien Charlotte	ULiège	0,000
7	Jacques Marie	ULiège	0,000
8	Maurel Solenne	ULiège	0,000
11	Geortay Julie	UCLouvain 2	0,000
12	Renaud Laura	UCLouvain 2	0,000
15	Wiseur Romane	UCLouvain 2	0,000
19	Delange Laura	HEVinci	0,000
28	VandenBroucke Hanne	KULeuven	0,000

Dos	Nom	Unif	Barres
16	Kohnenmergen Emma	HEVinci indiv	10,867
3	Gronemberger Eléa	UCLouvain 1	10,567
13	Charlotte Simon	UCLouvain 2	10,467
21	Leyder Juliette	HEVinci	10,200
14	Van Caenegem Elise	UCLouvain 2	9,900
12	Renaud Laura	UCLouvain 2	9,867
22	Tavernier Lola	HEVinci	9,800
27	Neyrinck Margot	KULeuven	9,700
5	Tasiaux Laurine	UCLouvain 1	9,467
1	Dochy Juliette	UCLouvain 1	9,133
2	Dumont Elise	UCLouvain 1	8,567
24	Harschène Sophie	Henallux	8,400
17	Van Caenegem Maëlle	UCLouvain indiv	8,400
30	Aerts Lois	KULeuven	8,000
4	Renders Wendy	UCLouvain 1	7,767
31	Aerts Mia	KULeuven	7,533
9	Back Natalia	UCLouvain 2	7,200
10	Crefcoeur Leslie	UCLouvain 2	7,167
18	Bruyeer Sabine	HEVinci	7,000
20	Jadot Emilie	HEVinci	6,833
29	Van Deyck Meredith	KULeuven	5,267
26	Lecomte Adélaïde	KULeuven	2,633
25	Vincart Chloé	Henallux	1,000
11	Geortay Julie	UCLouvain 2	0,000
15	Wiseur Romane	UCLouvain 2	0,000
19	Delange Laura	HEVinci	0,000
23	Vlaemynck Léa	HEVinci	0,000
28	VandenBroucke Hanne	KULeuven	0,000



## Classement individuel GAF par agrès : Championnat FSUB de Gymnastique 28 mars 2022

### GAF par Agrès

Dos	Nom	Unif	Poutre
16	Kohnenmergen Emma	HEVinci indiv	14,450
4	Renders Wendy	UCLouvain 1	11,750
29	Van Deyck Meredith	KULeuven	11,300
2	Dumont Elise	UCLouvain 1	11,150
5	Tasiaux Laurine	UCLouvain 1	11,050
13	Charlotte Simon	UCLouvain 2	11,050
14	Van Caenegem Elise	UCLouvain 2	10,850
24	Harschène Sophie	Henallux	10,750
27	Neyrinck Margot	KULeuven	10,700
12	Renaud Laura	UCLouvain 2	10,550
1	Dochy Juliette	UCLouvain 1	10,350
30	Aerts Lois	KULeuven	10,100
20	Jadot Emilie	HEVinci	10,000
21	Leyder Juliette	HEVinci	9,550
15	Wiseur Romane	UCLouvain 2	9,350
17	Van Caenegem Maëlle	UCLouvain indiv	8,700
26	Lecomte Adélaïde	KULeuven	8,250
31	Aerts Mia	KULeuven	8,250
9	Back Natalia	UCLouvain 2	8,200
22	Tavernier Lola	HEVinci	8,150
11	Geortay Julie	UCLouvain 2	7,800
18	Bruyeer Sabine	HEVinci	6,800
25	Vincart Chloé	Henallux	4,550
3	Gronemberger Eléa	UCLouvain 1	0,000
10	Crefcoeur Leslie	UCLouvain 2	0,000
19	Delange Laura	HEVinci	0,000
23	Vlaemynck Léa	HEVinci	0,000
28	VandenBroucke Hanne	KULeuven	0,000

Dos	Nom	Unif	Sol
16	Kohnenmergen Emma	HEVinci indiv	12,933
2	Dumont Elise	UCLouvain 1	12,467
4	Renders Wendy	UCLouvain 1	12,333
21	Leyder Juliette	HEVinci	12,167
27	Neyrinck Margot	KULeuven	12,133
13	Charlotte Simon	UCLouvain 2	11,933
5	Tasiaux Laurine	UCLouvain 1	11,400
1	Dochy Juliette	UCLouvain 1	11,333
9	Back Natalia	UCLouvain 2	11,267
11	Geortay Julie	UCLouvain 2	10,967
15	Wiseur Romane	UCLouvain 2	10,933
3	Gronemberger Eléa	UCLouvain 1	10,867
22	Tavernier Lola	HEVinci	10,833
14	Van Caenegem Elise	UCLouvain 2	10,667
29	Van Deyck Meredith	KULeuven	10,500
23	Vlaemynck Léa	HEVinci	10,400
17	Van Caenegem Maëlle	UCLouvain indiv	10,300
30	Aerts Lois	KULeuven	10,233
18	Bruyeer Sabine	HEVinci	10,200
26	Lecomte Adélaïde	KULeuven	10,133
10	Crefcoeur Leslie	UCLouvain 2	9,700
24	Harschène Sophie	Henallux	9,633
31	Aerts Mia	KULeuven	9,600
20	Jadot Emilie	HEVinci	9,567
25	Vincart Chloé	Henallux	9,167
12	Renaud Laura	UCLouvain 2	0,000
19	Delange Laura	HEVinci	0,000
28	VandenBroucke Hanne	KULeuven	0,000

## Classement par équipe GAF : Championnat FSUB de Gymnastique 28 mars 2022

### GAF par équipe

Dos	Nom	Unif	Saut	Barres	Poutre	Sol	
1	Dochy Juliette	UCLouvain 1		9,133	10,350		
2	Dumont Elise	UCLouvain 1	11,800	8,567	11,150	12,467	
3	Gronemberger Eléa	UCLouvain 1	11,350	10,567		10,867	
4	Renders Wendy	UCLouvain 1	11,050		11,750	12,333	
5	Tasiaux Laurine	UCLouvain 1	11,300	9,467	11,050	11,400	
			34,450	29,167	33,950	36,200	133,766667

Dos	Nom	Unif	Saut	Barres	Poutre	Sol	
9	Back Natalia	UCLouvain 2	10,750	7,200		11,267	
10	Crefcoeur Leslie	UCLouvain 2	11,450				
11	Geortay Julie	UCLouvain 2			7,800	10,967	
12	Renaud Laura	UCLouvain 2		9,867	10,550		
13	Charlotte Simon	UCLouvain 2	11,800	10,467		11,933	
14	Van Caenegem Elise	UCLouvain 2	11,950	9,900	10,850	10,667	
15	Wiseur Romane	UCLouvain 2			9,350		
			35,200	30,233	30,750	34,167	130,35

Dos	Nom	Unif	Saut	Barres	Poutre	Sol	
26	Lecomte Adélaïde	KULeuven			8,250	10,133	
27	Neyrinck Margot	KULeuven	11,750	9,700	10,700	12,133	
28	VandenBroucke Hann	KULeuven					
29	Van Deyck Meredith	KULeuven	11,200	5,267	11,300	10,500	
30	Aerts Lois	KULeuven	10,950	8,000	10,100		
31	Aerts Mia	KULeuven	10,900	7,533		9,600	
			33,900	25,233	32,100	32,767	124

Dos	Nom	Unif	Saut	Barres	Poutre	Sol	
18	Bruyeer Sabine	HEVinci	11,500	7,000	6,800	10,200	
19	Delange Laura	HEVinci					
20	Jadot Emilie	HEVinci		6,833	10,000	9,567	
21	Leyder Juliette	HEVinci	11,500	10,200	9,550		
22	Tavernier Lola	HEVinci	10,750	9,800	8,150	10,833	
23	Vlaemynck Léa	HEVinci	9,800			10,400	
			33,750	27,000	27,700	31,433	119,883

**Classement individuel GAM : Championnat FSUB de Gymnastique 28 mars 2022**

GAM										
Dos	Nom	Unif	Sol	Arçons	Anneaux	Saut	Barres	Rek	Total	Classement
40	Wiseur Valentin	UCLouvain	13,400	12,150	12,050	12,550	12,700	11,250	74,1	1
39	Wiseur Maxence	UCLouvain	13,150	12,100	11,250	12,400	12,350	12,800	74,05	2
49	Leemans Andi	Vrije Universiteit Brussel	12,750	11,800	11,750	12,850	12,250	9,300	70,7	3
41	Capioni Mattéo	KU Leuven	11,800	8,800	12,300	11,500	13,300	11,650	69,35	4
50	Van Lomberghen Michiel	Universiteit Gent	12,150	10,200	10,700	12,100	12,550	10,650	68,35	5
42	Marx Ruben	KU Leuven		10,550	13,850		12,600	13,650	50,65	6
43	Strauven Thibeau	KU Leuven	11,100		9,850	12,200	12,250		45,4	7
45	Vranken Nathan	KU Leuven	12,200	6,400	10,600	11,300			40,5	8
44	Vanden Auweele Oscar	KU Leuven		7,900		11,750	11,850	8,600	40,1	9
38	Van Caenegem Loïc	UCLouvain	12,750	11,100		12,800			36,65	10
33	Cassart Mathéo	UCLouvain					12,050	11,400	23,45	11
36	Pirard Julien	UCLouvain		9,600	10,750				20,35	12
37	Rubio Hugo	UCLouvain			8,850		9,750		18,6	13
34	Hinnekens Adrien	UCLouvain				11,300		6,850	18,15	14
35	Jacques Arthur	UCLouvain	10,850						10,85	15

## Classement individuel GAM par agrès : Championnat FSUB de Gymnastique 28 mars 2022

### GAM par Agrès

Dos	Nom	Unif	Sol
40	Wiseur Valentin	UCLouvain	13,40
39	Wiseur Maxence	UCLouvain	13,15
38	Van Caenegem Loïc	UCLouvain	12,75
49	Leemans Andi	Vrije Universiteit Brussel	12,75
45	Vranken Nathan	KU Leuven	12,20
50	Van Lomberghen Michiel	Universiteit Gent	12,15
41	Capioni Mattéo	KU Leuven	11,80
43	Strauven Thibeu	KU Leuven	11,10
35	Jacques Arthur	UCLouvain	10,85
33	Cassart Mathéo	UCLouvain	0,00
34	Hinnekins Adrien	UCLouvain	0,00
36	Pirard Julien	UCLouvain	0,00
37	Rubio Hugo	UCLouvain	0,00
42	Marx Ruben	KU Leuven	0,00
44	Vanden Auweele Oscar	KU Leuven	0,00

Dos	Nom	Unif	Arçons
40	Wiseur Valentin	UCLouvain	12,15
39	Wiseur Maxence	UCLouvain	12,1
49	Leemans Andi	Vrije Universiteit Brussel	11,8
38	Van Caenegem Loïc	UCLouvain	11,1
42	Marx Ruben	KU Leuven	10,55
50	Van Lomberghen Michiel	Universiteit Gent	10,2
36	Pirard Julien	UCLouvain	9,6
41	Capioni Mattéo	KU Leuven	8,8
44	Vanden Auweele Oscar	KU Leuven	7,9
45	Vranken Nathan	KU Leuven	6,4
33	Cassart Mathéo	UCLouvain	0,0
34	Hinnekins Adrien	UCLouvain	0,0
35	Jacques Arthur	UCLouvain	0,0
37	Rubio Hugo	UCLouvain	0,0
43	Strauven Thibeu	KU Leuven	0,0

Dos	Nom	Unif	Anneaux
42	Marx Ruben	KU Leuven	13,85
41	Capioni Mattéo	KU Leuven	12,3
40	Wiseur Valentin	UCLouvain	12,05
49	Leemans Andi	Vrije Universiteit Brussel	11,75
39	Wiseur Maxence	UCLouvain	11,25
36	Pirard Julien	UCLouvain	10,75
50	Van Lomberghen Michiel	Universiteit Gent	10,7
45	Vranken Nathan	KU Leuven	10,6
43	Strauven Thibeu	KU Leuven	9,85
37	Rubio Hugo	UCLouvain	8,85
33	Cassart Mathéo	UCLouvain	0,00
34	Hinnekins Adrien	UCLouvain	0,00
35	Jacques Arthur	UCLouvain	0,00
38	Van Caenegem Loïc	UCLouvain	0,00
44	Vanden Auweele Oscar	KU Leuven	0,00

Dos	Nom	Unif	Saut
49	Leemans Andi	Vrije Universiteit Brussel	12,85
38	Van Caenegem Loïc	UCLouvain	12,8
40	Wiseur Valentin	UCLouvain	12,55
39	Wiseur Maxence	UCLouvain	12,4
43	Strauven Thibeu	KU Leuven	12,2
50	Van Lomberghen Michiel	Universiteit Gent	12,1
44	Vanden Auweele Oscar	KU Leuven	11,75
41	Capioni Mattéo	KU Leuven	11,5
45	Vranken Nathan	KU Leuven	11,3
34	Hinnekins Adrien	UCLouvain	11,3
33	Cassart Mathéo	UCLouvain	0,0
35	Jacques Arthur	UCLouvain	0,0
36	Pirard Julien	UCLouvain	0,0
37	Rubio Hugo	UCLouvain	0,0
42	Marx Ruben	KU Leuven	0,0

## Classement individuel GAM par agrès : Championnat FSUB de Gymnastique 28 mars 2022

### GAM par Agrès

Dos	Nom	Unif	Barres
41	Capioni Mattéo	KU Leuven	13,3
40	Wiseur Valentin	UCLouvain	12,7
42	Marx Ruben	KU Leuven	12,6
50	Van Lomberghen Michiel	Universiteit Gent	12,55
39	Wiseur Maxence	UCLouvain	12,35
43	Strauven Thibea	KU Leuven	12,25
49	Leemans Andi	Vrije Universiteit Brussel	12,25
33	Cassart Mathéo	UCLouvain	12,05
44	Vanden Auweele Oscar	KU Leuven	11,85
37	Rubio Hugo	UCLouvain	9,75
34	Hinnekens Adrien	UCLouvain	0,0
35	Jacques Arthur	UCLouvain	0,0
36	Pirard Julien	UCLouvain	0,0
38	Van Caenegem Loïc	UCLouvain	0,0
45	Vranken Nathan	KU Leuven	0,0

Dos	Nom	Unif	Rek
42	Marx Ruben	KU Leuven	13,65
39	Wiseur Maxence	UCLouvain	12,8
41	Capioni Mattéo	KU Leuven	11,65
33	Cassart Mathéo	UCLouvain	11,4
40	Wiseur Valentin	UCLouvain	11,25
50	Van Lomberghen Michiel	Universiteit Gent	10,65
49	Leemans Andi	Vrije Universiteit Brussel	9,3
44	Vanden Auweele Oscar	KU Leuven	8,6
34	Hinnekens Adrien	UCLouvain	6,85
35	Jacques Arthur	UCLouvain	0,0
36	Pirard Julien	UCLouvain	0,0
37	Rubio Hugo	UCLouvain	0,0
38	Van Caenegem Loïc	UCLouvain	0,0
43	Strauven Thibea	KU Leuven	0,0
45	Vranken Nathan	KU Leuven	0,0

Dos	Nom	Unif	Rek
42	Marx Ruben	KU Leuven	13,65
39	Wiseur Maxence	UCLouvain	12,8
41	Capioni Mattéo	KU Leuven	11,65
33	Cassart Mathéo	UCLouvain	11,4
40	Wiseur Valentin	UCLouvain	11,25
50	Van Lomberghen Michiel	Universiteit Gent	10,65
49	Leemans Andi	Vrije Universiteit Brussel	9,3
44	Vanden Auweele Oscar	KU Leuven	8,6
34	Hinnekens Adrien	UCLouvain	6,85
35	Jacques Arthur	UCLouvain	0,0
36	Pirard Julien	UCLouvain	0,0
37	Rubio Hugo	UCLouvain	0,0
38	Van Caenegem Loïc	UCLouvain	0,0
43	Strauven Thibea	KU Leuven	0,0
45	Vranken Nathan	KU Leuven	0,0

## Classement par équipe GAM : Championnat FSUB de Gymnastique 28 mars 2022

GAM par équipe									
Dos	Nom	Unif	Sol	Arçons	Anneaux	Saut	Barres	Rek	
33	Cassart Mathéo	UCLouvain					12,050	11,400	
34	Hinnekens Adrien	UCLouvain				11,300		6,850	
35	Jacques Arthur	UCLouvain	10,850						
36	Pirard Julien	UCLouvain		9,600	10,750				
37	Rubio Hugo	UCLouvain			8,850		9,750		
38	Van Caenegem Loïc	UCLouvain	12,750	11,100		12,800			
39	Wiseur Maxence	UCLouvain	13,150	12,100	11,250	12,400	12,350	12,800	
40	Wiseur Valentin	UCLouvain	13,400	12,150	12,050	12,550	12,700	11,250	
			39,300	35,350	34,050	37,750	37,100	35,450	219

Dos	Nom	Unif	Sol	Arçons	Anneaux	Saut	Barres	Rek	
41	Capioni Mattéo	KU Leuven	11,800	8,800	12,300	11,500	13,300	11,650	
42	Marx Ruben	KU Leuven		10,550	13,850		12,600	13,650	
43	Strauven Thibeau	KU Leuven	11,100		9,850	12,200	12,250		
44	Vanden Auweele Oscar	KU Leuven		7,900		11,750	11,850	8,600	
45	Vranken Nathan	KU Leuven	12,200	6,400	10,600	11,300			
			35,100	27,250	36,750	35,450	38,150	33,900	206,600

Résultats du Championnat FSUB  
de Judo Individuel  
Salle de l'UMONS  
Mercredi 8 décembre 2021



# FSUB Judo Championship 08/12/2021 D-52

Competitors: 3

## Competitors

#	Name	Club	1	2	3	Wins	Pts	Pos
1	OLIVIA FILIPETTO (?) ULB			0	10	1	10	2
2	LUDIVINE GROSSI (?) UCLouvain Wolves		1		1	2	2	1
3	MARINA SOUSA ESPINHO (?) HEVinci		0	0		0	0	3

## Matches

Match	White			Blue	Result	Time
1	OLIVIA FILIPETTO	1	2	LUDIVINE GROSSI	0 - 1	4:00
2	OLIVIA FILIPETTO	1	3	MARINA SOUSA ESPINHO	10 - 0	3:55
3	LUDIVINE GROSSI	2	3	MARINA SOUSA ESPINHO	1 - 0	4:00

## Results

Pos	Name
1	LUDIVINE GROSSI UCLouvain Wolves
2	OLIVIA FILIPETTO ULB
3	MARINA SOUSA ESPINHO HEVinci

B.U.S.F. - F.S.U.B.





# FSUB Judo Championship 08/12/2021 D-57



Competitors: 8

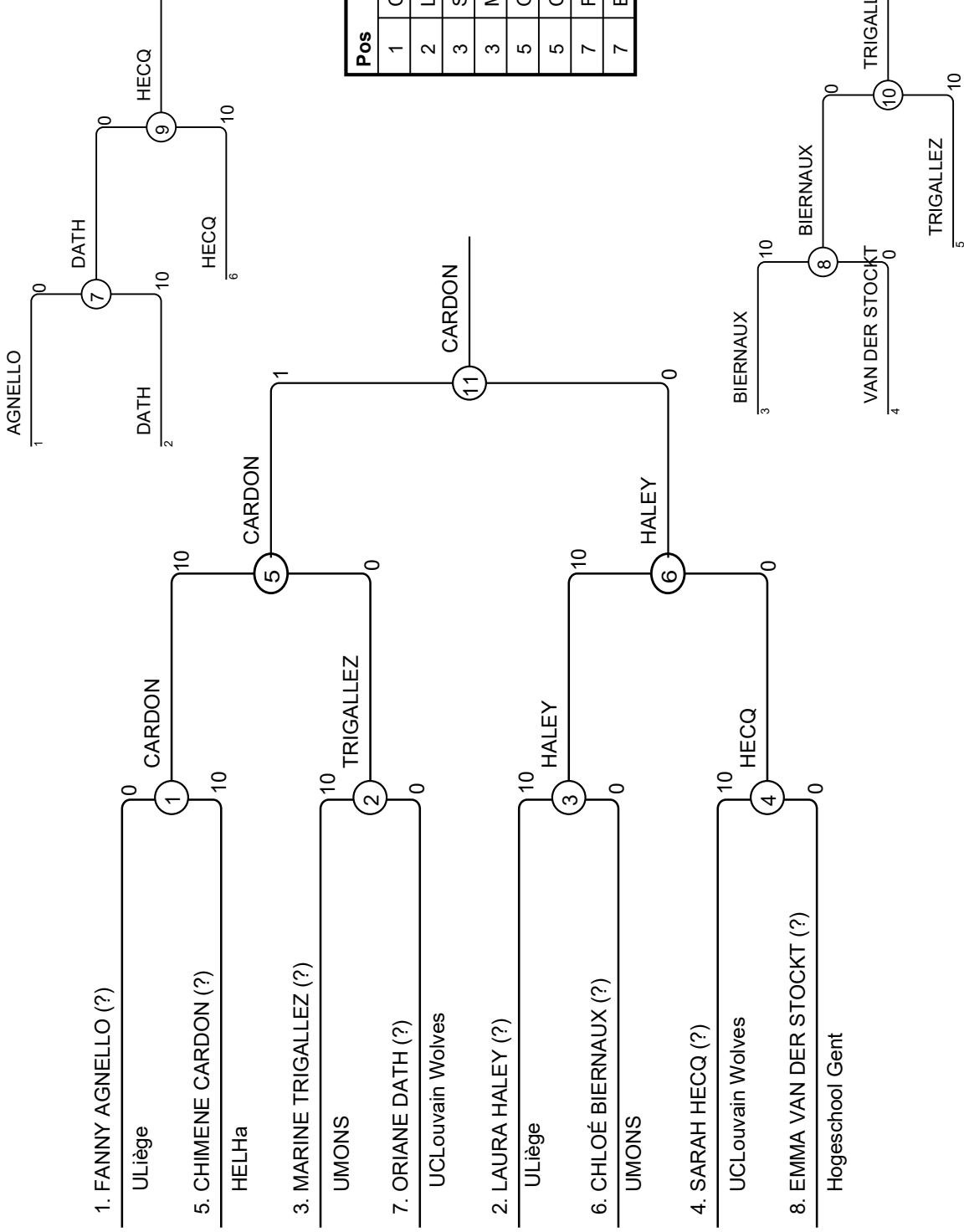

## Results

Pos	Name
1	CHIMENE CARDON HELHa
2	LAURA HALEY ULiège
3	SARAH HECQ UCLouvain Wolves
3	MARINE TRIGALLEZ UMONS
5	ORIANE DATH UCLouvain Wolves
5	CHLOÉ BIERNAUX UMONS
7	FANNY AGNELLO ULiège
7	EMMA VAN DER STOCKT Hogeschool Gent

# FSUB Judo Championship 08/12/2021 D-63

Competitors: 9

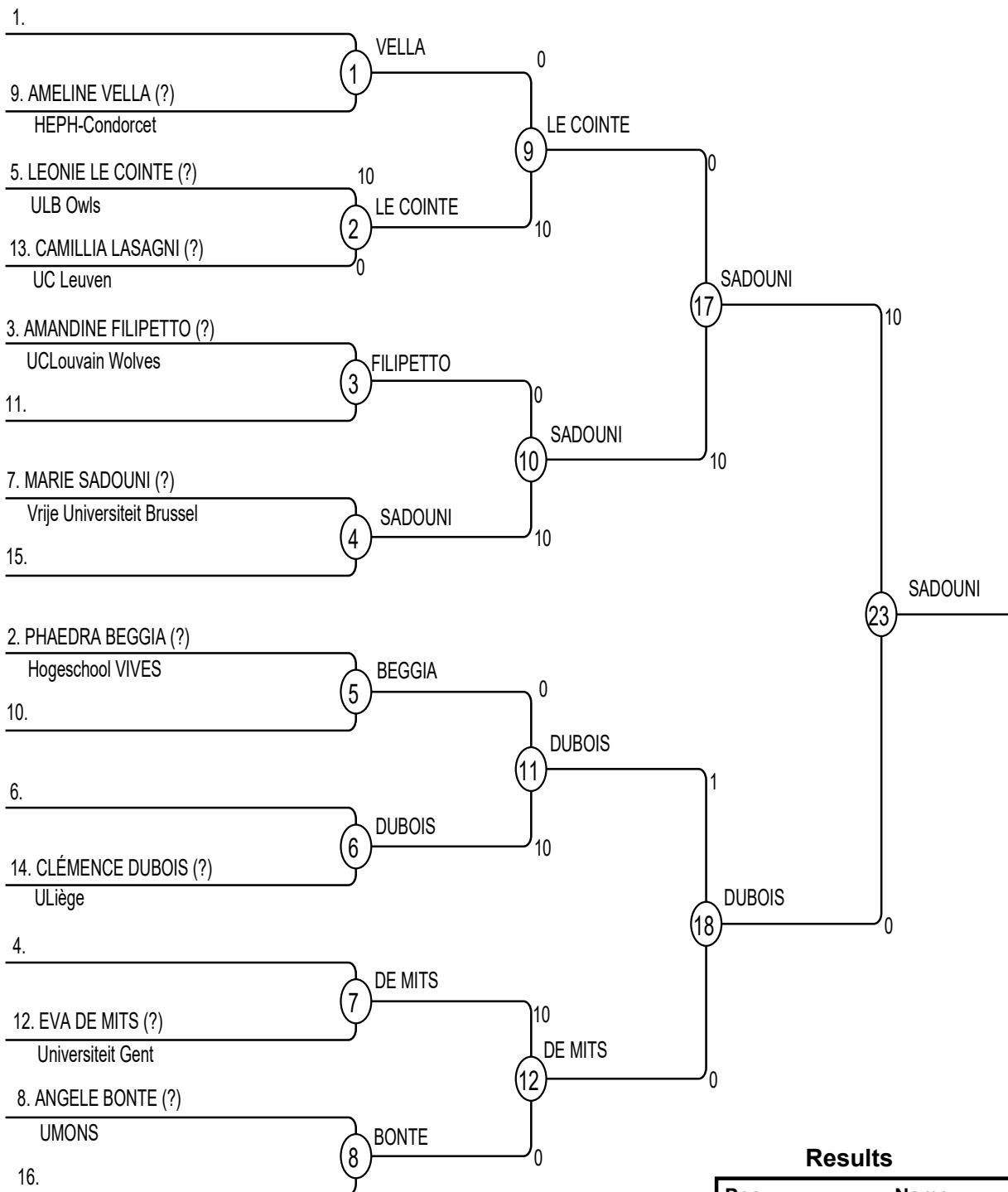

## Results

Pos	Name
1	MARIE SADOUNI Vrije Universiteit Brussel
2	CLÉMENCE DUBOIS ULiège
3	EVA DE MITS Universiteit Gent
3	LEONIE LE COINTE ULB Owls
5	CAMILLIA LASAGNI UC Leuven
5	PHAEDRA BEGGIA Hogeschool VIVES
7	AMANDINE FILIPETTO UCLouvain Wolves
7	ANGELE BONTE UMONS



# REPECHAGE

# FSUB Judo Championship 08/12/2021 D-63

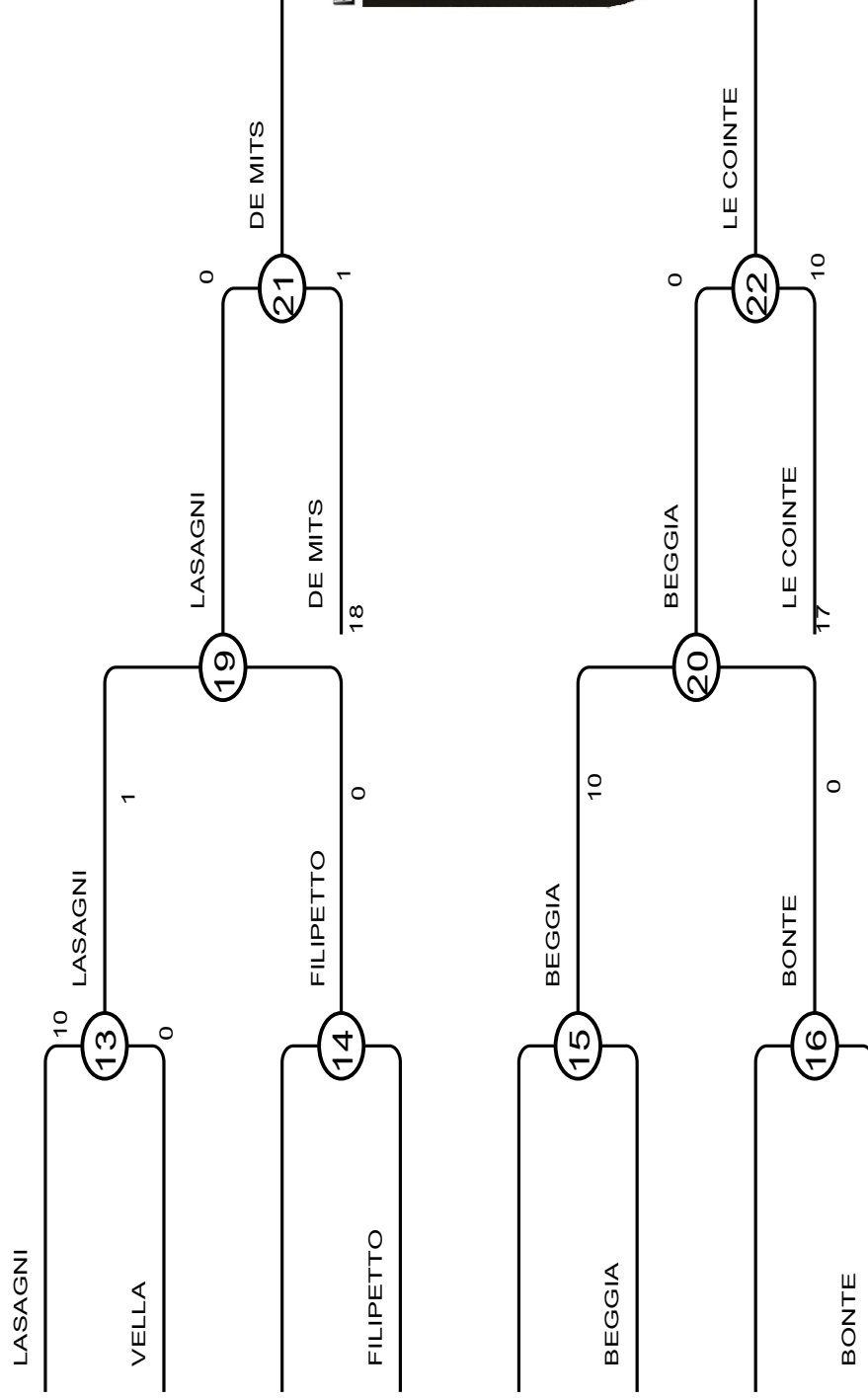

# FSUB Judo Championship 08/12/2021 D-70

Competitors: 4

## Competitors

#	Name	Club	1	2	3	4	Wins	Pts	Pos
1	MANON BUCHALLET (?) UCLouvain Wolves			0	0	10	1	10	3
2	LUCIE HECQ (?) UCLouvain Wolves		10		10	10	3	30	1
3	ANAËLLE DUFOUR CASTRONUOVO (?) Vrije Universiteit Brussel		10	0		10	2	20	2
4	LEÏLA BOUTANTIN (?) HEPH-Condorcet		0	0	0		0	0	4

## Matches

Match	White	Blue	Result	Time
1	MANON BUCHALLET	1 2 LUCIE HECQ	0 - 10	0:12
2	ANAËLLE DUFOUR CASTRONUOVO	3 4 LEÏLA BOUTANTIN	10 - 0	1:37
3	MANON BUCHALLET	1 3 ANAËLLE DUFOUR CASTRONUOVO	0 - 10	3:27
4	LUCIE HECQ	2 4 LEÏLA BOUTANTIN	10 - 0	0:20
5	MANON BUCHALLET	1 4 LEÏLA BOUTANTIN	10 - 0	
6	LUCIE HECQ	2 3 ANAËLLE DUFOUR CASTRONUOVO	10 - 0	1:40

## Results

Pos	Name
1	LUCIE HECQ UCLouvain Wolves
2	ANAËLLE DUFOUR CASTRONUOVO Vrije Universiteit Brussel
3	MANON BUCHALLET UCLouvain Wolves
4	LEÏLA BOUTANTIN HEPH-Condorcet

B.U.S.F. - F.S.U.B.



# FSUB Judo Championship 08/12/2021 D-78

Competitors: 1

## Competitors

#	Name	Club	1	Wins	Pts	Pos
1	MADELEINE BURTON (?) UCLouvain Wolves			0	0	1

## Matches

Match	White	Blue	Result	Time
-------	-------	------	--------	------

## Results

Pos	Name
1	MADELEINE BURTON UCLouvain Wolves

B.U.S.F. - F.S.U.B.



# FSUB Judo Championship 08/12/2021 H-60

Competitors: 5

## Competitors

#	Name	Club	1	2	3	4	5	Wins	Pts	Pos
1	ARNAUD VELLA (?) UMONS			0	0	0	0	0	0	5
2	SANDA ANDRIANJAKAVELO (?) ULB Owls		10		0	0	0	1	10	4
3	BENJAMIN ALJIJA (?) Hogeschool Gent		10	10		10	10	4	40	1
4	ARNAUD LALLEMAND (?) HEPL		10	10	0		0	2	20	3
5	JONAS GEERTS (?) Universiteit Gent		10	10	0	10		3	30	2

## Matches

Match	White	Blue	Result	Time
1	ARNAUD LALLEMAND	4 5 JONAS GEERTS	0 - 10	2:58
2	ARNAUD VELLA	1 2 SANDA ANDRIANJAKAVELO	0 - 10	0:47
3	BENJAMIN ALJIJA	3 4 ARNAUD LALLEMAND	10 - 0	1:17
4	ARNAUD VELLA	1 5 JONAS GEERTS	0 - 10	2:09
5	SANDA ANDRIANJAKAVELO	2 3 BENJAMIN ALJIJA	0 - 10	1:50
6	ARNAUD VELLA	1 4 ARNAUD LALLEMAND	0 - 10	0:46
7	BENJAMIN ALJIJA	3 5 JONAS GEERTS	10 - 0	2:08
8	SANDA ANDRIANJAKAVELO	2 4 ARNAUD LALLEMAND	0 - 10	4:48
9	ARNAUD VELLA	1 3 BENJAMIN ALJIJA	0 - 10	2:06
10	SANDA ANDRIANJAKAVELO	2 5 JONAS GEERTS	0 - 10	1:15

## Results

Pos	Name
1	BENJAMIN ALJIJA Hogeschool Gent
2	JONAS GEERTS Universiteit Gent
3	ARNAUD LALLEMAND HEPL
4	SANDA ANDRIANJAKAVELO ULB Owls
5	ARNAUD VELLA UMONS

B.U.S.F. - F.S.U.B.



# FSUB Judo Championship 08/12/2021 H-66



Competitors: 7

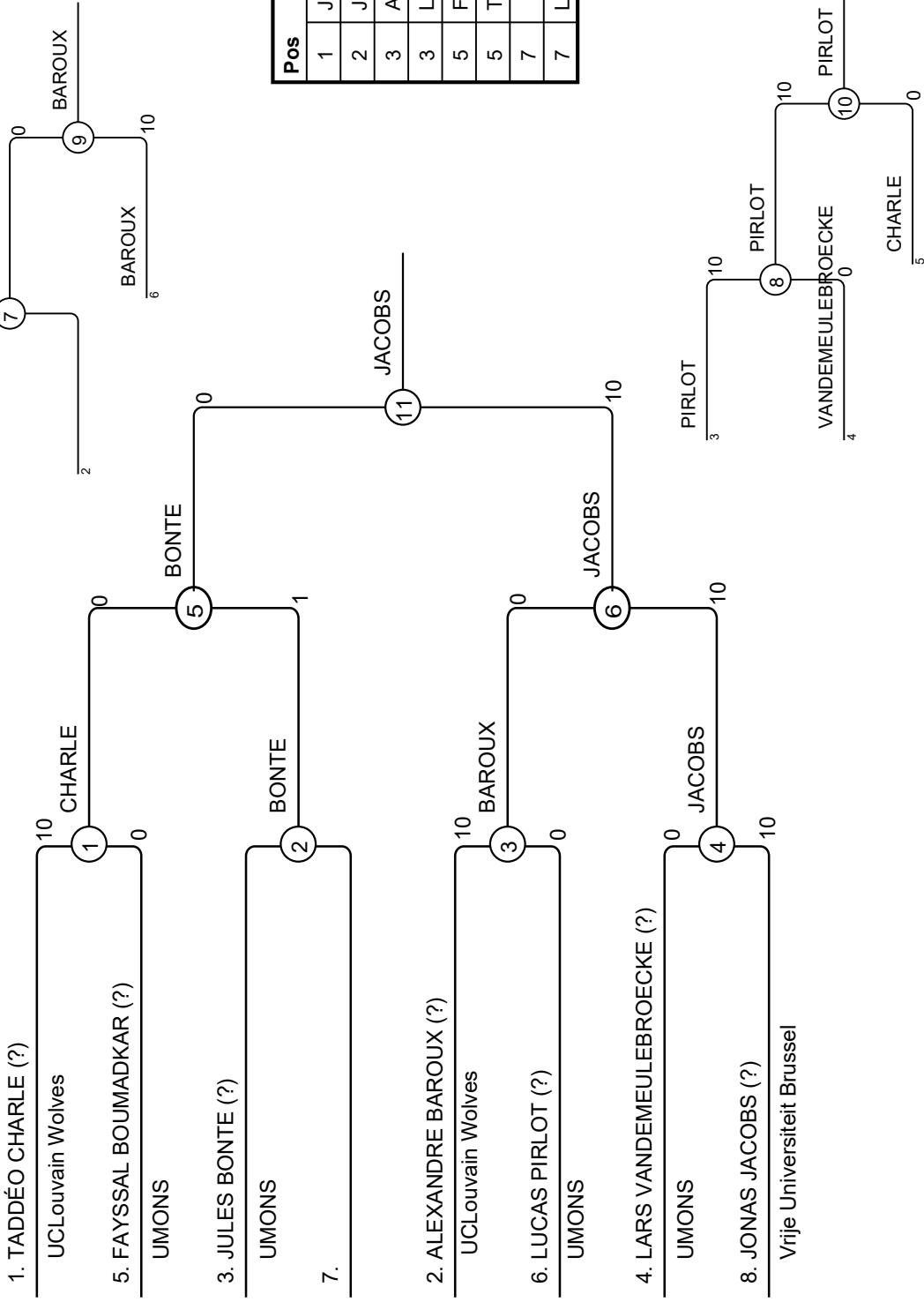

## Results

Pos	Name
1	JONAS JACOBS Vrije Universiteit Brussel
2	JULES BONTE UMONS
3	ALEXANDRE BAROUX UCLouvain Wolves
3	LUCAS PIRLOT UMONS
5	FAYSSAL BOUMADKAR UMONS
5	TADDÉO CHARLE UCLouvain Wolves
7	
7	LARS VANDEMEULEBROECKE UMONS

# FSUB Judo Championship 08/12/2021 H-73

Competitors: 13

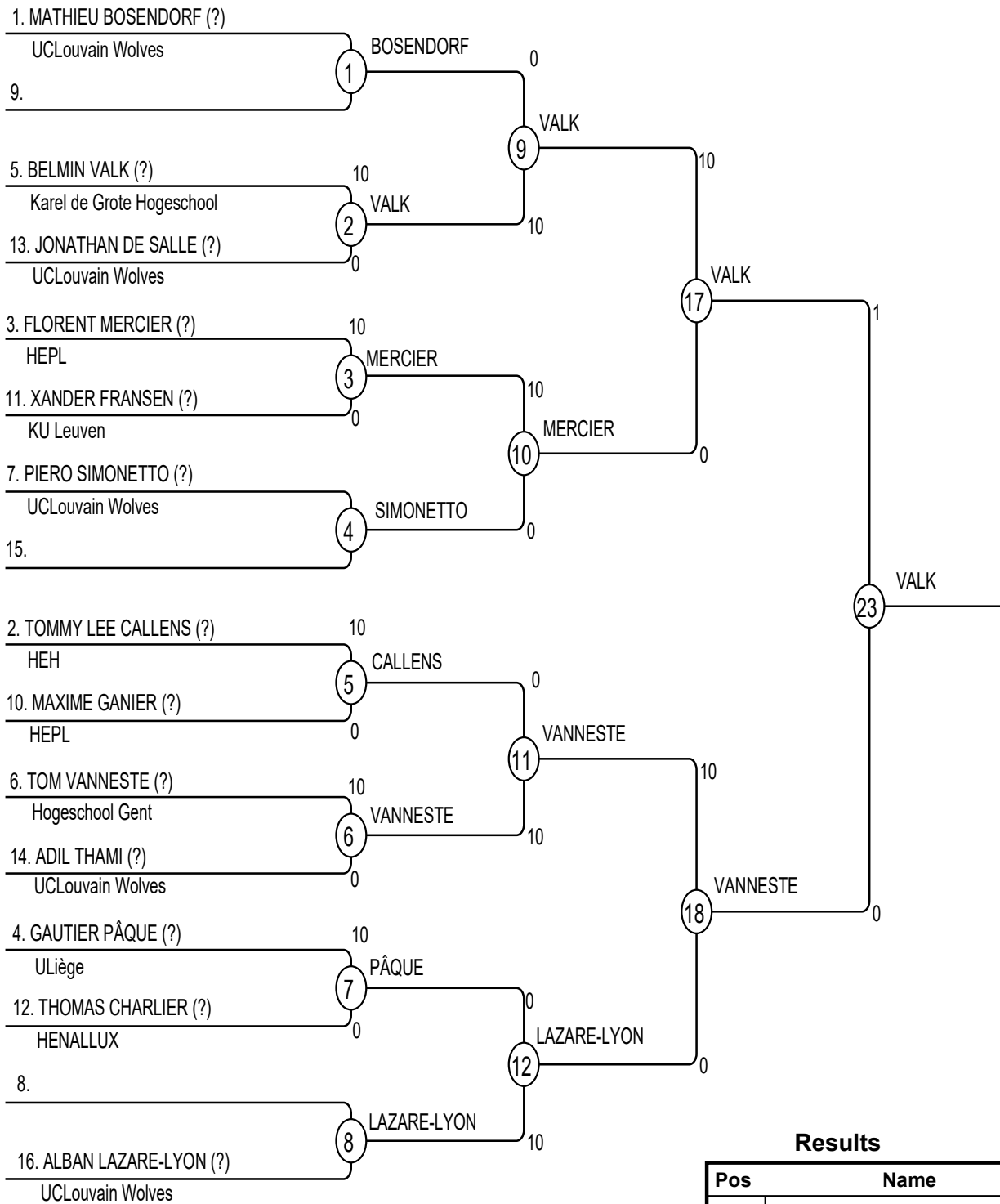

## Results

Pos	Name
1	BELMIN VALK Karel de Grote Hogeschool
2	TOM VANNESTE Hogeschool Gent
3	ALBAN LAZARE-LYON UCLouvain Wolves
3	GAUTIER PÂQUE ULiège
5	MATHIEU BOSENDORF UCLouvain Wolves
5	FLORENT MERCIER HEPL
7	XANDER FRANSEN KU Leuven
7	TOMMY LEE CALLENS HEH

B.U.S.F. - F.S.U.B.





# REPECHAGE

# FSUB Judo Championship 08/12/2021 H-73

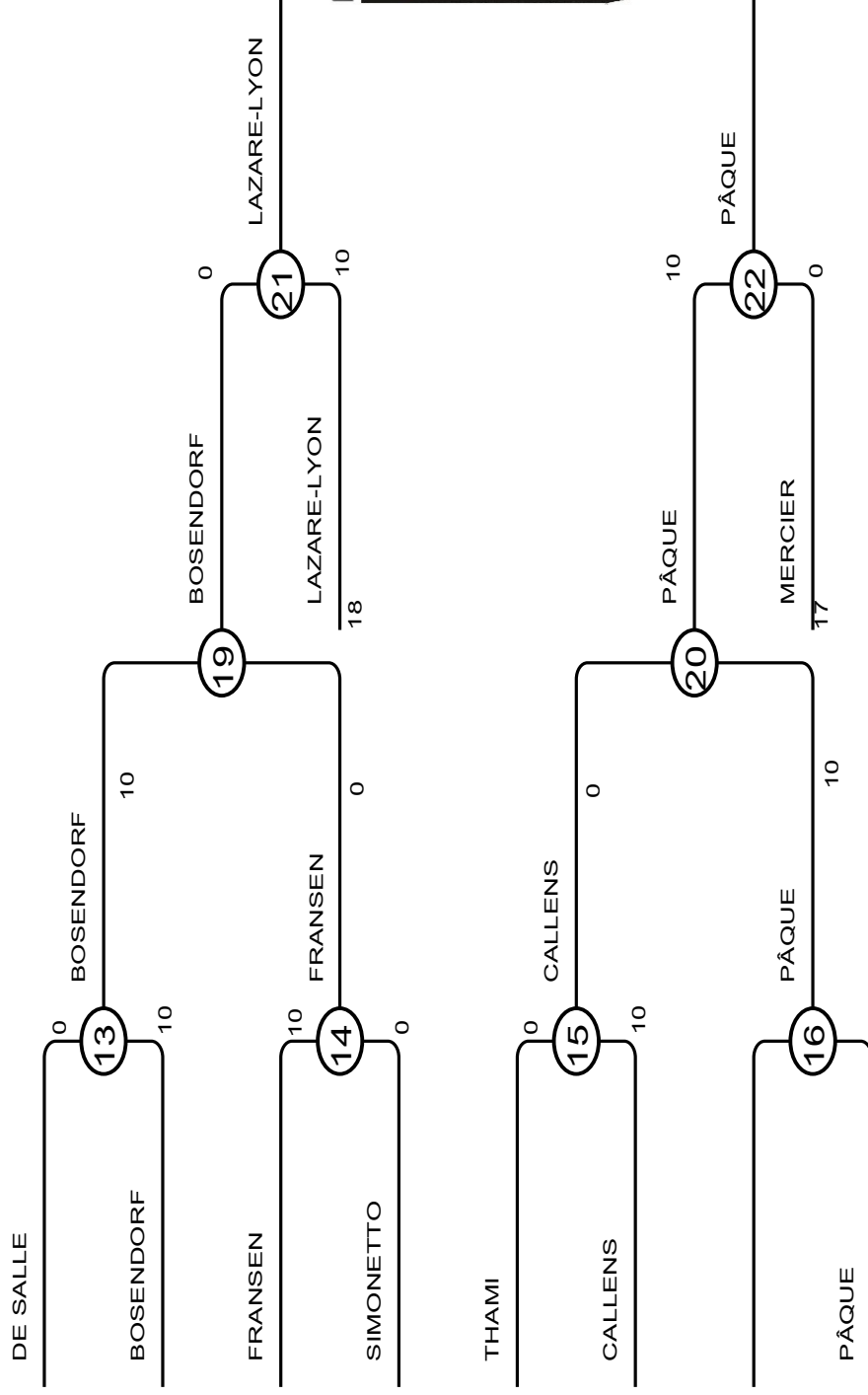

# FSUB Judo Championship 08/12/2021 H-81

Competitors: 12

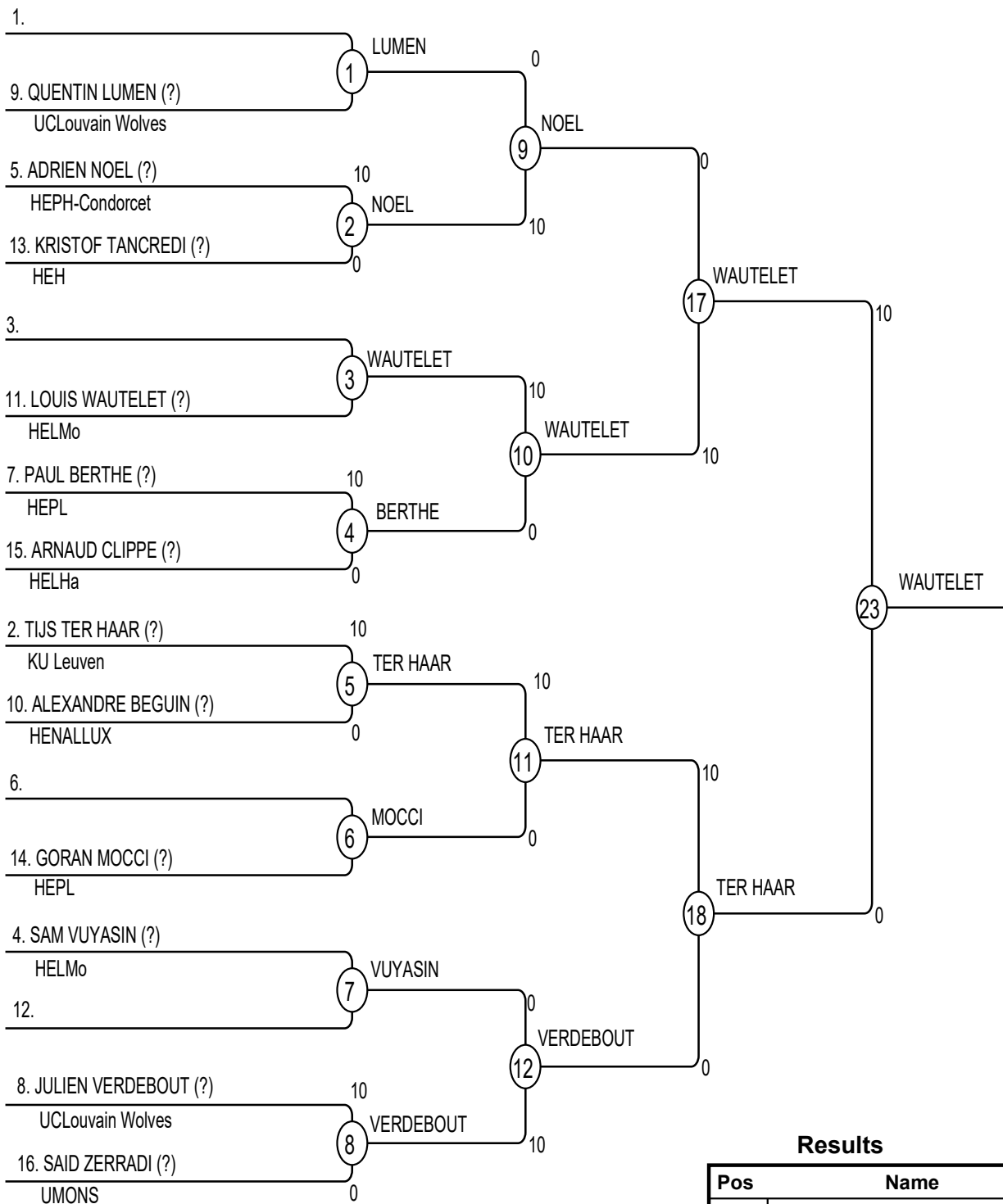

## Results

Pos	Name
1	LOUIS WAUTELET HELMo
2	TIJS TER HAAR KU Leuven
3	JULIEN VERDEBOUT UCLouvain Wolves
3	GORAN MOCCI HEPL
5	PAUL BERTHE HEPL
5	ADRIEN NOEL HEPH-Condorcet
7	QUENTIN LUMEN UCLouvain Wolves
7	SAM VUYASIN HELMo



# REPECHAGE

# FSUB Judo Championship 08/12/2021 H-81

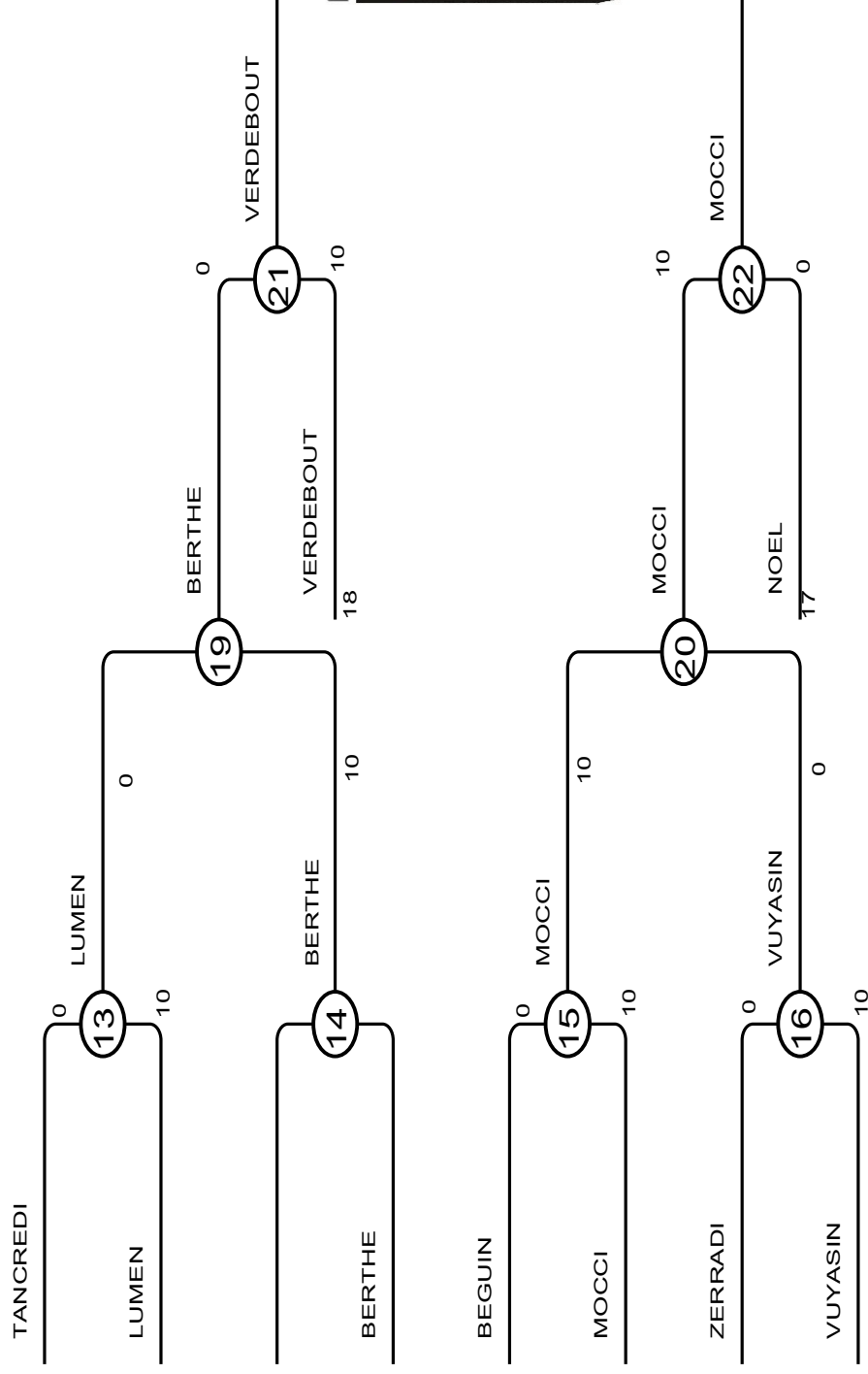

# FSUB Judo Championship 08/12/2021 H-90



Competitors: 6

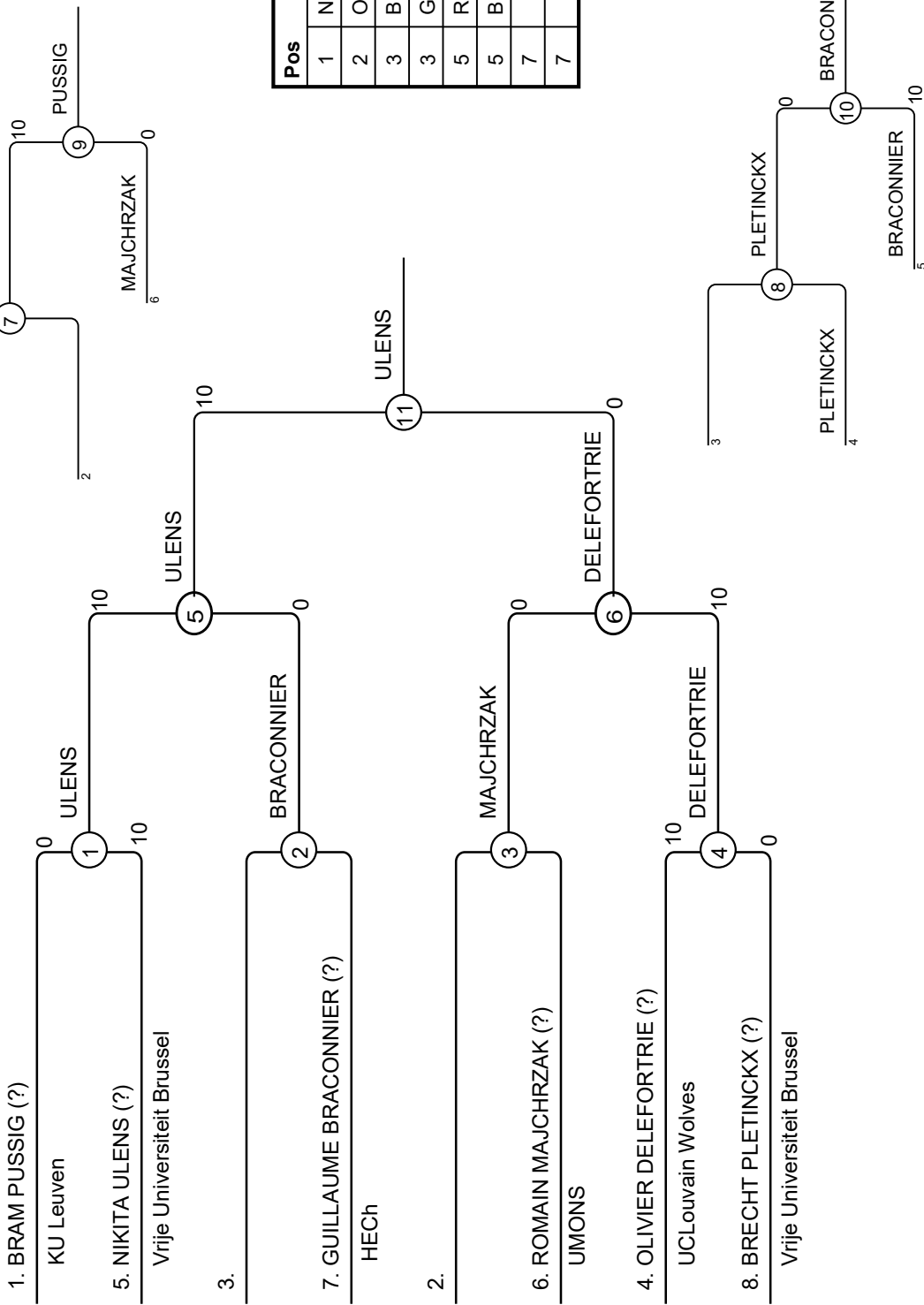

## Results

Pos	Name
1	NIKITA ULENS Vrije Universiteit Brussel
2	OLIVIER DELEFORTRIE UCLowain Wolves
3	BRAM PUSSIG KU Leuven
3	GUILLAUME BRACONNIER HECh
5	ROMAIN MAJCHRZAK UMONS
5	BRECHT PLETINCKX Vrije Universiteit Brussel
7	
7	

# FSUB Judo Championship 08/12/2021 H-100

Competitors: 5

## Competitors

#	Name	Club	1	2	3	4	5	Wins	Pts	Pos
1	LOÏC NICOLAIJE (?) HELB			0	10	10	10	3	30	2
2	JOSE CASTILLO TANGER (?) HEVinci		10		10	10	10	4	40	1
3	TENGIZ ALOUYAN (?) HELMo		0	0		10	10	2	20	3
4	NEMO GHIDETTI (?) UMONS		0	0	0		10	1	10	4
5	JOE EKANGA (?) UMONS		0	0	0	0		0	0	5

## Matches

Match	White	Blue	Result	Time
1	NEMO GHIDETTI	4 5 JOE EKANGA	10 - 0	2:16
2	LOÏC NICOLAIJE	1 2 JOSE CASTILLO TANGER	0 - 10	0:37
3	TENGIZ ALOUYAN	3 4 NEMO GHIDETTI	10 - 0	0:46
4	LOÏC NICOLAIJE	1 5 JOE EKANGA	10 - 0	1:54
5	JOSE CASTILLO TANGER	2 3 TENGIZ ALOUYAN	10 - 0	2:12
6	LOÏC NICOLAIJE	1 4 NEMO GHIDETTI	10 - 0	0:50
7	TENGIZ ALOUYAN	3 5 JOE EKANGA	10 - 0	0:11
8	JOSE CASTILLO TANGER	2 4 NEMO GHIDETTI	10 - 0	0:34
9	LOÏC NICOLAIJE	1 3 TENGIZ ALOUYAN	10 - 0	0:37
10	JOSE CASTILLO TANGER	2 5 JOE EKANGA	10 - 0	1:36

## Results

Pos	Name
1	JOSE CASTILLO TANGER HEVinci
2	LOÏC NICOLAIJE HELB
3	TENGIZ ALOUYAN HELMo
4	NEMO GHIDETTI UMONS
5	JOE EKANGA UMONS

B.U.S.F. - F.S.U.B.



# FSUB Judo Championship 08/12/2021 H+100

Competitors: 3

## Competitors

#	Name	Club	1	2	3	Wins	Pts	Pos
1	AUDRIC SCHMITZ (?) HEPL			10	10	2	20	1
2	MARIËN INGA (?) ECAM		0		0	0	0	3
3	SOUFIANE AL AYACHI (?) UCLouvain Wolves		0	10		1	10	2

## Matches

Match	White			Blue	Result	Time
1	AUDRIC SCHMITZ	1	2	MARIËN INGA	10 - 0	1:15
2	AUDRIC SCHMITZ	1	3	SOUFIANE AL AYACHI	10 - 0	0:16
3	MARIËN INGA	2	3	SOUFIANE AL AYACHI	0 - 10	1:00

## Results

Pos	Name
1	AUDRIC SCHMITZ HEPL
2	SOUFIANE AL AYACHI UCLouvain Wolves
3	MARIËN INGA ECAM

B.U.S.F. - F.S.U.B.



# Résultats du Championnat FSUB de judo par équipe

Centre Sportif KULeuven

Mercredi 9 mars 2022



**KU LEUVEN**





**Belgisch Studentenkampioenschap - Championnat de Belgique d'étudiants**  
**Universitair Sportcentrum KU Leuven**  
**9 maart 2022**

**POULE A**

**Judo Mixed Teams**

		1		2		3		Match	WINS	POINTS	PLACE	
1	<b>UCLouvain Wolves 1</b> ASEUS	1			1		1		2	10	102	1
					4	41	6	61				
2	<b>KU LEUVEN</b> Studentensport Vlaanderen	2	0				0		0	7	63	3
			4	32			3	31				
3	<b>HEPL</b> Aseus	3	0		1				1	7	71	2
			2	21	5	50						

Wedstrijdduur: 4'

Match	
Wins	TP





Belgisch Studentenkampioenschap - Championnat de Belgique d'étudiants

Universitair Sportcentrum KU Leuven

9 maart 2022

**POULE B**

**Judo Mixed Teams**

		1		2		3		Match	WINS	POINTS	PLACE	
4	<b>UCLouvain Wolves 2</b> ASEUS	1			0		1		1	7	70	2
					2	20	5	50				
5	<b>UGENT</b> Studetensport Vlaanderen	2	1				1		2	10	100	1
			6	60			4	40				
6	<b>UMons</b> ASEUS	3	0		0				0	6	51	3
			3	30	3	21						

Wedstrijdduur: 4'

Match	
Wins	TP

## Judo Mixed Teams

Wedstrijdduur : 4'

½ Finale

Finale

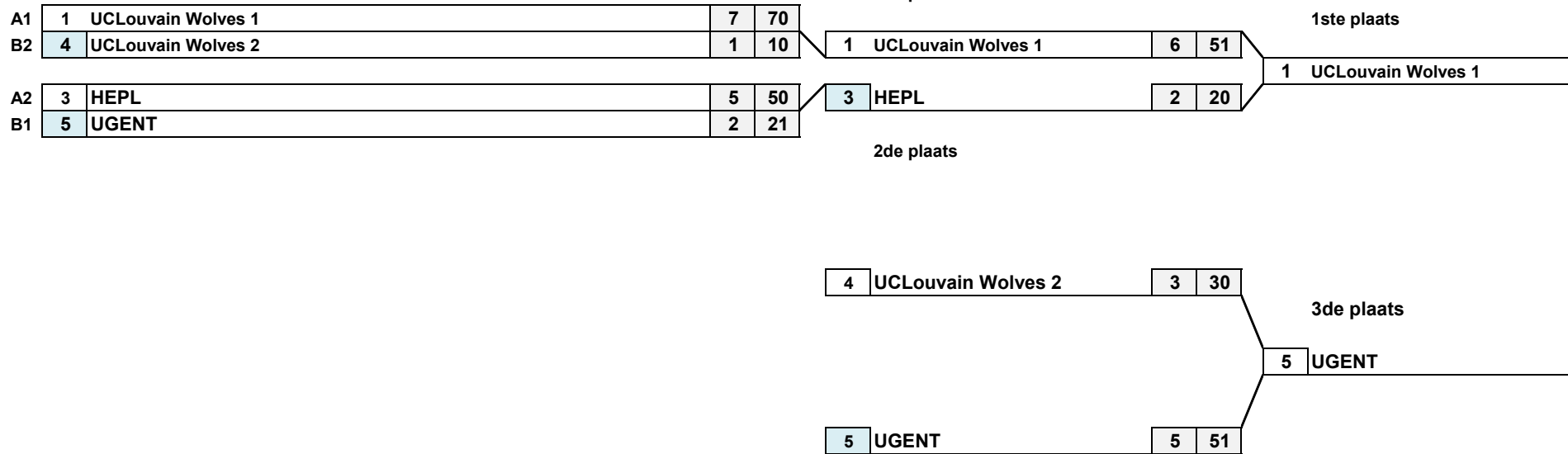

Belgisch Studentenkampioenschap - Championnat de Belgique d'étudiants  
 Universitair Sportcentrum KU Leuven  
 09/03/22



# Résultats du Championnat FSUB de Natation

Complexe Sportif de Blocry

Louvain-la-Neuve

Mercredi 23 mars 2022



Liste des médaillés par épreuve

Toutes les épreuves

1. Dames, 100m Libre					Cat. générale
1. VANLOMMEL, Anke	BEL	KU LEUVEN	57.96	<b>58.66</b>	
2. COETS, Shannon	BEL	UCL	57.99	<b>59.86</b>	
3. HARZÉ, Marine	BEL	ULG (LG)	58.89	<b>1:00.71</b>	
2. Messieurs, 100m Libre					Cat. générale
1. CAMPS, Roeland	BEL	KU LEUVEN	53.05	<b>53.68</b>	
2. MORIAU, Thibault	BEL	UCL	51.87	<b>53.84</b>	
3. COOREVITS, Simon	BEL	HOWEST	53.37	<b>54.59</b>	
3. Dames, 100m Brasse					Cat. générale
1. DELMOTTE, Elodie	BEL	UCL	1:13.86	<b>1:15.38</b>	
2. STREPENNE, Elisa	BEL	HEPL	1:16.29	<b>1:17.94</b>	
3. ELIARD, Tania	BEL	UCL	1:17.20	<b>1:21.56</b>	
4. Messieurs, 100m Brasse					Cat. générale
1. HUBERTY, Mathieu	BEL	ULB	1:08.00	<b>1:09.74</b>	
2. DEBONGNIE, Nathan	BEL	EPHEC	1:09.95	<b>1:13.58</b>	
3. DENEFF, Grégoire	BEL	UCL	1:12.63	<b>1:13.62</b>	
5. Dames, 200m 4 nages					Cat. générale
1. DELMOTTE, Elodie	BEL	UCL	2:29.68	<b>2:38.29</b>	
2. COLMANT, Lise	BEL	UCL	3:10.00	<b>2:56.17</b>	
3. THEATE, Laure-Hélène	BEL	HEPL	3:05.00	<b>3:03.64</b>	
6. Messieurs, 200m 4 nages					Cat. générale
1. VANDAMME, Hugo	BEL	HEPHC	2:08.01	<b>2:13.88</b>	
2. DEBONGNIE, Aymeric	BEL	UCL	2:13.21	<b>2:17.76</b>	
3. VAN EETVELT, Mattias	BEL	UCL	2:24.00	<b>2:18.14</b>	
7. Dames, 100m Dos					Cat. générale
1. COETS, Shannon	BEL	UCL	1:06.69	<b>1:10.14</b>	
2. DUBOIS, Zoé	BEL	UCL	1:14.62	<b>1:16.54</b>	
3. FRIPPIAT, Lory	BEL	HEPL	1:20.00	<b>1:17.10</b>	
8. Messieurs, 100m Dos					Cat. générale
1. SEMPELS, Gilles	BEL	KU LEUVEN	59.57	<b>1:01.33</b>	
2. BALHAUT, Augustin	BEL	UCL	1:00.03	<b>1:02.36</b>	
3. VERBEEK, Mats	BEL	KU LEUVEN	1:00.24	<b>1:03.66</b>	
9. Dames, 50m Brasse					Cat. générale
1. DUMONT, Josephine	BEL	UCL	32.29	<b>35.24</b>	
2. STREPENNE, Elisa	BEL	HEPL	34.79	<b>35.66</b>	
3. ELIARD, Tania	BEL	UCL	36.65	<b>37.70</b>	

Championnat Belge Enseignement Universitaire et supérieur 2022  
Louvain-la-Neuve, 23-3-2022

10. Messieurs, 200m Brasse					Cat. générale
1.	HUBERTY, Mathieu	BEL	ULB	2:35.00	<b>2:38.78</b>
2.	DENOLF, Ward	BEL	ERM	NT	<b>2:40.82</b>
3.	DEBONGNIE, Nathan	BEL	EPHEC	2:34.91	<b>2:42.41</b>
11. Dames, 100m Papillon					Cat. générale
1.	CHEDAL, Valentine	BEL	UCL	1:30.00	<b>1:24.91</b>
12. Messieurs, 100m Papillon					Cat. générale
1.	VANDAMME, Hugo	BEL	HEPHC	55.67	<b>57.00</b>
2.	BAECKELMANS, Jarne	BEL	ERM	56.59	<b>57.15</b>
3.	CAMPS, Roeland	BEL	KU LEUVEN	58.12	<b>59.44</b>
13. Dames, 50m Libre					Cat. générale
1.	KENNIS, Nathalie	BEL	KU LEUVEN	27.33	<b>26.18</b>
2.	VANLOMMEL, Anke	BEL	KU LEUVEN	26.40	<b>26.73</b>
3.	HARZÉ, Marine	BEL	ULG (LG)	27.27	<b>27.92</b>
14. Messieurs, 200m Libre					Cat. générale
1.	COOREVITS, Simon	BEL	HOWEST	1:58.68	<b>1:59.84</b>
2.	DI BATTISTA, Alessandro	BEL	HE2B	1:55.73	<b>2:07.71</b>
3.	LAROCHE, Florian	BEL	UCL	2:15.00	<b>2:09.19</b>
15. Dames, 50m Dos					Cat. générale
1.	REMY-PAQUAY, Mazarin	BEL	ERM	32.22	<b>34.08</b>
2.	DOM, Elize	BEL	KU LEUVEN	35.23	<b>34.26</b>
3.	NIETO RODRIGUEZ, Laur	BEL	KU LEUVEN	33.56	<b>34.28</b>
16. Messieurs, 200m Dos					Cat. générale
1.	BALHAUT, Augustin	BEL	UCL	2:09.68	<b>2:16.19</b>
2.	DEBONGNIE, Aymeric	BEL	UCL	2:11.45	<b>2:18.81</b>
3.	VERBEEK, Mats	BEL	KU LEUVEN	2:15.40	<b>2:22.21</b>
17. Dames, 50m Papillon					Cat. générale
1.	DUMONT, Josephine	BEL	UCL	30.86	<b>30.99</b>
2.	VAN DE VELPEN, Emma	BEL	KU LEUVEN	36.84	<b>32.87</b>
3.	FRIPPIAT, Lory	BEL	HEPL	50.00	<b>33.57</b>
18. Messieurs, 50m Libre					Cat. générale
1.	DELHAYE, Bastien	BEL	ULB	23.90	<b>24.42</b>
2.	FEUILLEN, David	BEL	HEPL	25.18	<b>24.70</b>
3.	AERTS-BANCKEN, Guilla	BEL	HEPL	23.17	<b>24.84</b>
19. Dames, 4 x 50m 4 nages					Cat. générale
1.	UCL 1	BEL	UCL	NT	<b>2:08.52</b>
2.	KUL 1	BEL	KU LEUVEN	NT	<b>2:08.95</b>
3.	HEPL 1	BEL	HEPL	NT	<b>2:16.92</b>

Championnat Belge Enseignement Universitaire et supérieur 2022  
Louvain-la-Neuve, 23-3-2022

---

20. Messieurs, 4 x 50m 4 nages Cat. générale

---

1. HEPL	BEL	HEPL	NT	<b>1:52.31</b>
2. UCL 1	BEL	UCL	NT	<b>1:53.72</b>
3. ULB 1	BEL	ULB	NT	<b>1:54.18</b>

---

21. Dames, 4 x 50m Libre Cat. générale

---

1. KUL 1	BEL	KU LEUVEN	NT	<b>1:53.86</b>
2. UCL 1	BEL	UCL	NT	<b>1:58.58</b>
3. ERM 1	BEL	ERM	NT	<b>2:09.11</b>

---

22. Messieurs, 4 x 50m Libre Cat. générale

---

1. KUL 1	BEL	KU LEUVEN	NT	<b>1:41.16</b>
2. UCL 1	BEL	UCL	NT	<b>1:43.36</b>
3. ULB 1	BEL	ULB	NT	<b>1:43.87</b>

---

23. Mixte, 10 x 50m Libre Cat. générale

---

1. KUL 1	BEL	KU LEUVEN	NT	<b>4:24.88</b>
2. UCL 1	BEL	UCL	NT	<b>4:33.65</b>
3. HEPL	BEL	HEPL	NT	<b>4:47.25</b>

Championnat Belge Enseignement Universitaire et supérieur 2022  
Louvain-la-Neuve, 23-3-2022

Epreuve 1 Dames, 100m Libre Cat. générale  
23-03-22 Liste résultats

Points: FINA 2021

Rang			Temps	Pts	50m	100m
1.	VANLOMMEL, Anke	BEL KU LEUVEN	<b>58.66</b>	628		
2.	COETS, Shannon	BEL UCL	<b>59.86</b>	591		
3.	HARZÉ, Marine	BEL ULG (LG)	<b>1:00.71</b>	567		
4.	GARCIA ZAMORA, Ilona	BEL HEPL	<b>1:01.10</b>	556		
5.	WATELLE, Anna	BEL KU LEUVEN	<b>1:01.34</b>	549		
6.	SCHEPENS, Thiele	BEL HOGESCHOOL GENT	<b>1:06.95</b>	422		
7.	DELAHAUT, Romane	BEL ULB	<b>1:07.16</b>	418		
8.	BLOTHIAUX, Aline	BEL UCL	<b>1:08.34</b>	397		
9.	CORNELISSEN, Dali	BEL KU LEUVEN	<b>1:09.98</b>	370		
10.	VAN LAEKEN, Lauryne	BEL UCL	<b>1:11.97</b>	340		
11.	PARENT, Elise	BEL ERM	<b>1:17.09</b>	276		
12.	CLOUET, Anaïs	BEL ULB	<b>1:20.83</b>	240		
hc.	HAEVERANS, Stien	BEL KU LEUVEN	<b>1:15.99</b>	289		

Epreuve 2 Messieurs, 100m Libre Cat. générale  
23-03-22 Liste résultats

Points: FINA 2021

Rang			Temps	Pts	50m	100m
1.	CAMPS, Roeland	BEL KU LEUVEN	<b>53.68</b>	586		
2.	MORIAU, Thibault	BEL UCL	<b>53.84</b>	581		
3.	COOREVITS, Simon	BEL HOWEST	<b>54.59</b>	557		
4.	FEUILLEN, David	BEL HEPL	<b>54.95</b>	547		
5.	VAN BOGAERT, Bram	BEL KU LEUVEN T	<b>56.55</b>	501		
6.	ROBIN, Thomas	BEL ULB	<b>57.14</b>	486		
7.	DI BATTISTA, Alessandro	BEL HE2B	<b>57.18</b>	485		
8.	LAROCHE, Florian	BEL UCL	<b>57.47</b>	478		
9.	VAN DER DONCKT, Steffen	BEL KU LEUVEN	<b>58.35</b>	456		
10.	HOUTEVELT, Kyllian	BEL ULB	<b>59.31</b>	435		
11.	FLAMAND, Timon	BEL ULB	<b>1:00.91</b>	401		
12.	VERSTRAETE, Edouard	BEL UCL	<b>1:01.48</b>	390		
13.	DELPIERRE, Maxime	BEL HE2B	<b>1:02.25</b>	376		
forf.nd.	PIERRET, Noah	BEL HERS				
forf.nd.	JEGO, Akira	BEL ULB				
forf.nd.	VERSÉZ, Younes	BEL KU LEUVEN T				

Epreuve 3 Dames, 100m Brasse Cat. générale  
23-03-22 Liste résultats

Points: FINA 2021

Rang			Temps	Pts	50m	100m
1.	DELMOTTE, Elodie	BEL UCL	<b>1:15.38</b>	566		
2.	STREPENNE, Elisa	BEL HEPL	<b>1:17.94</b>	512		
3.	ELIARD, Tania	BEL UCL	<b>1:21.56</b>	446		
4.	DITTING, Juljana	BEL ULB	<b>1:29.46</b>	338		
5.	LAVENS, Camille	BEL HEPL	<b>1:38.05</b>	257		
6.	CHEDAL, Valentine	BEL UCL	<b>1:39.10</b>	249		

Championnat Belge Enseignement Universitaire et supérieur 2022  
Louvain-la-Neuve, 23-3-2022

Epreuve 4 Messieurs, 100m Brasse Cat. générale  
Liste résultats

Points: FINA 2021

Rang			Temps	Pts	50m	100m
1.	HUBERTY, Mathieu	BEL ULB	<b>1:09.74</b>	499		
2.	DEBONGNIE, Nathan	BEL EPHEC	<b>1:13.58</b>	425		
3.	DENEF, Grégoire	BEL UCL	<b>1:13.62</b>	424		
4.	GREGOIRE, Juan	BEL UCL	<b>1:13.84</b>	420		
5.	VANDERHULST, Tobe	BEL KU LEUVEN	<b>1:14.57</b>	408		
6.	CAMPS, Viktor	BEL KU LEUVEN T	<b>1:14.79</b>	405		
7.	LELIÈVRE-DAMIT, Jonas	BEL KU LEUVEN	<b>1:14.92</b>	403		
8.	RICKER, Adrien	BEL HEPL	<b>1:21.32</b>	315		
9.	IBBERSON, William	BEL UCL	<b>1:23.84</b>	287		
10.	HOUVENAGHEL, Brecht	BEL ERM	<b>1:29.74</b>	234		
forf.nd.	DE ELÍAS, Alberto	BEL ULB				
forf.nd.	ORBAN, Olivier	BEL THOMAS MORE				

Epreuve 5 Dames, 200m 4 nages Cat. générale  
Liste résultats

Rang	Nat	Licence	Tps inscr.	Temps	50m	100m	150m	200m
1.	DELMOTTE, Elodie	BEL UCL	2:29.68	<b>2:38.29</b>				
2.	COLMANT, Lise	BEL UCL	3:10.00	<b>2:56.17</b>				
3.	THEATE, Laure-Hélène	BEL HEPL	3:05.00	<b>3:03.64</b>				
4.	VANKEVELAER, nele	BEL KU LEUVEN	2:59.38	<b>3:05.16</b>				
5.	DE MEULEMEESTER, Nad	BEL UCL	3:10.00	<b>3:08.56</b>				

Epreuve 6 Messieurs, 200m 4 nages Cat. générale  
Liste résultats

Rang	Nat	Licence	Tps inscr.	Temps	50m	100m	150m	200m
1.	VANDAMME, Hugo	BEL HEPHC	2:08.01	<b>2:13.88</b>				
2.	DEBONGNIE, Aymeric	BEL UCL	2:13.21	<b>2:17.76</b>				
3.	VAN EETVELT, Mattias	BEL UCL	2:24.00	<b>2:18.14</b>				
4.	BISENIUS, Ryan	BEL HEPL	2:20.00	<b>2:22.63</b>				
5.	DENISON, Antoine	BEL UCL	2:24.66	<b>2:25.40</b>				
6.	NIETO, Rodriguez	BEL KU LEUVEN T	2:28.36	<b>2:27.72</b>				
7.	SPRUYT, Linus	BEL KU LEUVEN T	2:35.65	<b>2:28.10</b>				
8.	TICOALU, Evano	BEL THOMAS MORE	2:22.30	<b>2:32.58</b>				
9.	HEYMANS, Quinten	BEL KU LEUVEN	2:34.73	<b>2:35.51</b>				
10.	WARICHET, Nicolas	BEL ULB	2:40.00	<b>2:49.58</b>				
11.	POIRAUD, Ellie	BEL HEPL	NT	<b>3:01.94</b>				

Epreuve 7 Dames, 100m Dos Cat. générale  
Liste résultats

Points: FINA 2021

Rang			Temps	Pts	50m	100m
1.	COETS, Shannon	BEL UCL	<b>1:10.14</b>	479		
2.	DUBOIS, Zoé	BEL UCL	<b>1:16.54</b>	368		
3.	FRIPPIAT, Lory	BEL HEPL	<b>1:17.10</b>	360		
4.	RONDEAU, Lola	BEL UCL	<b>1:17.40</b>	356		
5.	SCHEPENS, Thiele	BEL HOGESCHOOL GENT	<b>1:18.67</b>	339		
6.	VANKEVELAER, nele	BEL KU LEUVEN	<b>1:24.03</b>	278		
7.	BROERE, Lieke	BEL KU LEUVEN	<b>1:26.99</b>	251		



Championnat Belge Enseignement Universitaire et supérieur 2022  
Louvain-la-Neuve, 23-3-2022

Epreuve 8 Messieurs, 100m Dos Cat. générale  
23-03-22 Liste résultats

Points: FINA 2021

Rang			Temps	Pts	50m	100m
1.	SEMPELS, Gilles	BEL KU LEUVEN	<b>1:01.33</b>	489		
2.	BALHAUT, Augustin	BEL UCL	<b>1:02.36</b>	465		
3.	VERBEEK, Mats	BEL KU LEUVEN	<b>1:03.66</b>	437		
4.	ROBIN, Thomas	BEL ULB	<b>1:06.16</b>	389		
5.	JANSSENS, Florian	BEL ULB	<b>1:07.96</b>	359		
6.	GOFFARD, Eduardo	BEL KU LEUVEN	<b>1:10.12</b>	327		
7.	MORIAU, Amaury	BEL EPHEC	<b>1:11.55</b>	308		
8.	VAN HAUWAERT, Joachim	BEL UCL	<b>1:12.98</b>	290		
9.	OTTEVAERE, Damien	BEL UNAMUR	<b>1:13.56</b>	283		
10.	HOUSSIÈRE, Pierre	BEL UCL	<b>1:21.07</b>	211		
11.	POIRAUD, Ellie	BEL HEPL	<b>1:29.24</b>	158		
forf.nd.	TICOALU, Evano	BEL THOMAS MORE				

Epreuve 9 Dames, 50m Brasse Cat. générale  
23-03-22 Liste résultats

Rang	Nom	Licence	T.I.	Temps final
1.	DUMONT, Josephine	BEL UCL	32.29	<b>35.24</b>
2.	STREPENNE, Elisa	BEL HEPL	34.79	<b>35.66</b>
3.	ELIARD, Tania	BEL UCL	36.65	<b>37.70</b>
4.	VERHENNE, Kaat	BEL KU LEUVEN	45.00	<b>41.53</b>
5.	LAVENS, Camille	BEL HEPL	50.00	<b>43.66</b>
6.	GIESBERTS, Mirte	BEL KU LEUVEN	41.78	<b>45.21</b>
7.	MESSIAEN, Emeline	BEL UCL	40.00	<b>45.60</b>
forf.nd.	DITTING, Juljana	BEL ULB	40.00	
forf.nd.	SPINCEMAILLE, Laura	BEL KU LEUVEN	35.93	

Epreuve 10 Messieurs, 200m Brasse Cat. générale  
23-03-22 Liste résultats

Rang	Nat	Licence	Tps inscr.	Temps	50m	100m	150m	200m
1.	HUBERTY, Mathieu	BEL ULB	2:35.00	<b>2:38.78</b>				
2.	DENOLF, Ward	BEL ERM	NT	<b>2:40.82</b>				
3.	DEBONGNIE, Nathan	BEL EPHEC	2:34.91	<b>2:42.41</b>				
4.	HOUTEVELT, Kyllian	BEL ULB	2:52.18	<b>2:44.78</b>				
5.	DENEUF, Grégoire	BEL UCL	2:39.57	<b>2:46.84</b>				
6.	HOUSSIÈRE, Pierre	BEL UCL	2:44.99	<b>2:48.71</b>				
7.	ÖZGENER, Öke	BEL KU LEUVEN	3:01.22	<b>2:58.18</b>				
8.	RICKER, Adrien	BEL HEPL	2:50.00	<b>2:58.43</b>				
9.	D'HONT, Cyril	BEL UCL	2:50.00	<b>3:18.48</b>				
forf.nd.	ORBAN, Olivier	BEL THOMAS MORE	2:27.43					

Championnat Belge Enseignement Universitaire et supérieur 2022  
Louvain-la-Neuve, 23-3-2022

Epreuve 11 Dames, 100m Papillon Cat. générale  
23-03-22 Liste résultats

Points: FINA 2021

Rang			Temps	Pts	50m	100m
1.	CHEDAL, Valentine	BEL UCL	<b>1:24.91</b>	266		

Epreuve 12 Messieurs, 100m Papillon Cat. générale  
23-03-22 Liste résultats

Points: FINA 2021

Rang			Temps	Pts	50m	100m
1.	VANDAMME, Hugo	BEL HEPHC	<b>57.00</b>	588		
2.	BAECKELMANS, Jarne	BEL ERM	<b>57.15</b>	584		
3.	CAMPS, Roeland	BEL KU LEUVEN	<b>59.44</b>	519		
4.	MORIAU, Thibault	BEL UCL	<b>59.50</b>	517		
5.	DELHAYE, Bastien	BEL ULB	<b>59.90</b>	507		
6.	VERBEEK, Bram	BEL KU LEUVEN	<b>1:00.38</b>	495		
7.	VAN EETVELT, Mattias	BEL UCL	<b>1:03.68</b>	422		
8.	DENISON, Antoine	BEL UCL	<b>1:04.02</b>	415		
9.	MOORE, Matthias	BEL UGENT	<b>1:04.46</b>	407		
10.	HOLLEVOET, Robbe	BEL KU LEUVEN	<b>1:08.37</b>	341		
11.	WARICHET, Nicolas	BEL ULB	<b>1:23.06</b>	190		
forf.nd.	AERTS-BANCKEN, Guillaume	BEL HEPL				

Epreuve 13 Dames, 50m Libre Cat. générale  
23-03-22 Liste résultats

Rang	Nom	Licence	T.I.	Temps final
1.	KENNIS, Nathalie	BEL KU LEUVEN	27.33	<b>26.18</b>
2.	VANLOMMEL, Anke	BEL KU LEUVEN	26.40	<b>26.73</b>
3.	HARZÉ, Marine	BEL ULG (LG)	27.27	<b>27.92</b>
4.	GARCIA ZAMORA, Ilona	BEL HEPL	28.12	<b>28.64</b>
5.	REMY-PAQUAY, Mazarin	BEL ERM	29.27	<b>29.42</b>
6.	JANVIER, Zoé	BEL ULB	30.00	<b>31.78</b>
7.	VAN LAEKEN, Lauryne	BEL UCL	32.93	<b>32.59</b>
8.	MOMMEN, Inès	BEL ERM	30.30	<b>33.25</b>
9.	MAUXION, Pauline	BEL ULB	33.00	<b>33.98</b>
10.	AMEYE, Jorijn	BEL KU LEUVEN	33.69	<b>34.18</b>
11.	MESSIAEN, Emeline	BEL UCL	33.00	<b>34.26</b>
12.	VILLERET, Sophie	BEL ULB	34.00	<b>34.63</b>
13.	THEATE, Laure-Hélène	BEL HEPL	38.00	<b>34.65</b>
14.	MAHE, Louise	BEL ULB	35.00	<b>35.14</b>
15.	CLOUET, Anaïs	BEL ULB	35.00	<b>36.67</b>
16.	MALUENDA DRAPER, C.	BEL HEPL	50.00	<b>37.36</b>
forf.nd.	VAN OLMEN, Jill	BEL KU LEUVEN	29.96	

Championnat Belge Enseignement Universitaire et supérieur 2022  
Louvain-la-Neuve, 23-3-2022

Epreuve 14  
23-03-22

Messieurs, 200m Libre

Cat. générale  
Liste résultats

Rang	Nom	Nat	Licence	Tps inscr.	Temps	50m	100m	150m	200m
1.	COOREVITS, Simon	BEL	HOWEST	1:58.68	<b>1:59.84</b>				
2.	DI BATTISTA, Alessandro	BEL	HE2B	1:55.73	<b>2:07.71</b>				
3.	LAROCHE, Florian	BEL	UCL	2:15.00	<b>2:09.19</b>				
4.	VERSTRAETE, Edouard	BEL	UCL	2:14.00	<b>2:10.87</b>				
5.	HEYMANS, Quinten	BEL	KU LEUVEN	2:07.29	<b>2:14.84</b>				
6.	HOLLEVOET, Robbe	BEL	KU LEUVEN	2:03.70	<b>2:19.74</b>				
7.	BAFFREY, Xavier	BEL	UCL	2:11.35	<b>2:19.98</b>				
8.	GOFFARD, Eduardo	BEL	KU LEUVEN	2:20.00	<b>2:22.38</b>				
forf.nd.	FLAMAND, Timon	BEL	ULB	2:30.00					
forf.nd.	VERSÉZ, Younes	BEL	KU LEUVEN T	2:02.00					

Epreuve 15  
23-03-22

Dames, 50m Dos

Cat. générale  
Liste résultats

Rang	Nom	Nat	Licence	T.I.	Temps final
1.	REMY-PAQUAY, Mazarin	BEL	ERM	32.22	<b>34.08</b>
2.	DOM, Elize	BEL	KU LEUVEN	35.23	<b>34.26</b>
3.	NIETO RODRIGUEZ, Laur	BEL	KU LEUVEN	33.56	<b>34.28</b>
4.	DUBOIS, Zoé	BEL	UCL	36.65	<b>35.15</b>
5.	RONDEAU, Lola	BEL	UCL	33.98	<b>35.94</b>
6.	BLOTHIAUX, Aline	BEL	UCL	36.67	<b>37.94</b>
7.	BROERE, Lieke	BEL	KU LEUVEN	37.59	<b>39.05</b>
8.	MAHE, Louise	BEL	ULB	38.00	<b>39.63</b>
forf.nd.	DE ELIAS, Pilar	BEL	ULB	40.00	
forf.nd.	VILLERET, Sophie	BEL	ULB	38.00	

Epreuve 16  
23-03-22

Messieurs, 200m Dos

Cat. générale  
Liste résultats

Rang	Nom	Nat	Licence	Tps inscr.	Temps	50m	100m	150m	200m
1.	BALHAUT, Augustin	BEL	UCL	2:09.68	<b>2:16.19</b>				
2.	DEBONGNIE, Aymeric	BEL	UCL	2:11.45	<b>2:18.81</b>				
3.	VERBEEK, Mats	BEL	KU LEUVEN	2:15.40	<b>2:22.21</b>				
4.	VAN HAUWAERT, Joachim	BEL	UCL	2:28.52	<b>2:52.68</b>				
forf.nd.	GLINEUR, Raphael	BEL	HEPHC	2:28.15					

Epreuve 17  
23-03-22

Dames, 50m Papillon

Cat. générale  
Liste résultats

Rang	Nom	Nat	Licence	T.I.	Temps final
1.	DUMONT, Josephine	BEL	UCL	30.86	<b>30.99</b>
2.	VAN DE VELPEN, Emma	BEL	KU LEUVEN	36.84	<b>32.87</b>
3.	FRIPPIAT, Lory	BEL	HEPL	50.00	<b>33.57</b>
4.	DELAHAUT, Romane	BEL	ULB	35.00	<b>34.15</b>
5.	CORNELISSEN, Dali	BEL	KU LEUVEN	30.93	<b>35.69</b>
6.	COLMANT, Lise	BEL	UCL	36.00	<b>36.06</b>
7.	MAUXION, Pauline	BEL	ULB	37.00	<b>36.91</b>
8.	DE MEULEMEESTER, Na	BEL	UCL	37.00	<b>37.06</b>
9.	AMEYE, Jorijn	BEL	KU LEUVEN	37.74	<b>38.28</b>
forf.nd.	SPINCEMAILLE, Laura	BEL	KU LEUVEN	30.38	

Championnat Belge Enseignement Universitaire et supérieur 2022  
Louvain-la-Neuve, 23-3-2022

Epreuve 17, Dames, 50m Papillon, Cat. générale

Rang	Nom	Licence	T.I.	Temps final
forf.nd.	VAN OLMEN, Jill	BEL KU LEUVEN	34.41	

Epreuve 18  
23-03-22

Messieurs, 50m Libre

Cat. générale  
Liste résultats

Rang	Nom	Licence	T.I.	Temps final
1.	DELHAYE, Bastien	BEL ULB	23.90	<b>24.42</b>
2.	FEUILLEN, David	BEL HEPL	25.18	<b>24.70</b>
3.	AERTS-BANCKEN, Guillaume	BEL HEPL	23.17	<b>24.84</b>
4.	VERBEEK, Bram	BEL KU LEUVEN	23.60	<b>24.91</b>
5.	PIERARD, Geoffrey	BEL HEPL	24.74	<b>25.67</b>
6.	LELIÈVRE-DAMIT, Jonas	BEL KU LEUVEN	24.30	<b>25.70</b>
7.	SEMPELS, Gilles	BEL KU LEUVEN	24.49	<b>25.78</b>
8.	GREGOIRE, Juan	BEL UCL	24.52	<b>26.32</b>
9.	AMBROES, Benjamin	BEL HEVINCI	25.72	<b>26.39</b>
10.	MOORE, Matthias	BEL UGENT	25.91	<b>26.43</b>
11.	DENOLF, Ward	BEL ERM	NT	<b>26.78</b>
12.	JEGO, Akira	BEL ULB	27.00	<b>26.99</b>
13.	DELPierre, Maxime	BEL HE2B	28.00	<b>27.58</b>
14.	JANSSENS, Florian	BEL ULB	26.34	<b>27.66</b>
15.	MORIAU, Amaury	BEL EPHEC	29.50	<b>27.99</b>
16.	PENNEMAN, Alexandre	BEL ERM	28.40	<b>28.05</b>
17.	FONLUPT, Frederic	BEL UCL	35.94	<b>29.00</b>
18.	OTTEVAERE, Damien	BEL UNAMUR	30.30	<b>29.06</b>
19.	IBBERSON, William	BEL UCL	27.32	<b>29.59</b>
forf.nd.	GLINEUR, Raphael	BEL HEPHC	25.50	
forf.nd.	PIERRET, Noah	BEL HERS	29.30	
forf.nd.	AKROUT, Amen	BEL HEVINCI	27.50	

Epreuve 19  
23-03-22

Dames, 4 x 50m 4 nages

Cat. générale  
Liste résultats

Rang	Nom	Licence	T.I.	Temps final
1.	UCL 1 DUMONT, Josephine DELMOTTE, Elodie	BEL UCL 02 99	NT COETS, Shannon DUBOIS, Zoé	<b>2:08.52</b> 01 03
2.	KUL 1 WATELLE, Anna VERHENNE, Kaat	BEL KU LEUVEN 03 00	NT VANLOMMEL, Anke KENNIS, Nathalie	<b>2:08.95</b> 00 02
3.	HEPL 1 GARCIA ZAMORA, Ilona STREPENNE, Elisa	BEL HEPL 03 00	NT FRIPPIAT, Lory THEATE, Laure-Hélène	<b>2:16.92</b> 00 00
4.	UCL 2 RONDEAU, Lola ELIARD, Tania	BEL UCL 03 02	NT COLMANT, Lise DE MEULEMEESTER, Nadège	<b>2:21.13</b> 92 00
5.	KUL 2 BROERE, Lieke DOM, Elize	BEL KU LEUVEN 03 00	NT NIETO RODRIGUEZ, Laura VAN DE VELPEN, Emma	<b>2:21.84</b> 00 00
6.	ERM 1 VABNDEMALELE, Lucie REMY-PAQUAY, Mazarine	BEL ERM 00 02	NT MOMMEN, Inès PARENT, Elise	<b>2:25.36</b> 99 02

Championnat Belge Enseignement Universitaire et supérieur 2022  
Louvain-la-Neuve, 23-3-2022

Epreuve 19, Dames, 4 x 50m 4 nages, Cat. générale

Rang	Licence	T.I.	Temps final
disq. ULB 2	BEL ULB	NT	<b>2:26.25</b>
<i>SW 10.11 - Départ anticipé du 2ème, 3ème ou 4ème nageur</i>			
VILLERET, Sophie	02	DELAHAUT, Romane	99
JANVIER, Zoé	00	CLOUET, Anaïs	03
forf.nd. ULB 1	BEL ULB	NT	

Epreuve 20  
23-03-22

Messieurs, 4 x 50m 4 nages

Cat. générale  
Liste résultats

Rang	Licence	T.I.	Temps final
1. HEPL	BEL HEPL	NT	<b>1:52.31</b>
FEUILLEN, David	99	AERTS-BANCKEN, Guillaume	96
PIERARD, Geoffrey	98	BISENIUS, Ryan	00
2. UCL 1	BEL UCL	NT	<b>1:53.72</b>
DEBONGNIE, Aymeric	99	MORIAU, Thibault	99
GREGOIRE, Juan	01	DENISON, Antoine	02
3. ULB 1	BEL ULB	NT	<b>1:54.18</b>
ROBIN, Thomas	00	DELHAYE, Bastien	02
HUBERTY, Mathieu	96	DE ELÍAS, Alberto	92
4. KUL 1	BEL KU LEUVEN	NT	<b>1:57.61</b>
VERBEEK, Mats	01	HOLLEVOET, Robbe	02
VANDERHULST, Tobe	03	VAN DER DONCKT, Steffen	98
5. KUL T	BEL KU LEUVEN T	NT	<b>1:58.94</b>
VAN BOGAERT, Bram	98	NIETO, Rodriguez	02
CAMPS, Viktor	03	SPRUYT, Linus	02
6. UCL 2	BEL UCL	NT	<b>2:00.28</b>
BALHAUT, Augustin	03	VAN EETVELT, Mattias	00
DENEFF, Grégoire	01	IBBERSON, William	03
7. ULB 2	BEL ULB	NT	<b>2:02.67</b>
JANSSENS, Florian	02	JEGO, Akira	96
HOUTEVELT, Kyllian	02	FLAMAND, Timon	01
disq. KUL 2	BEL KU LEUVEN	NT	<b>1:50.06</b>
<i>SW 10.11 - Départ anticipé du 2ème, 3ème ou 4ème nageur</i>			
SEMPELS, Gilles	02	CAMPS, Roeland	01
LELIÈVRE-DAMIT, Jonas	97	VERBEEK, Bram	99

Epreuve 21  
23-03-22

Dames, 4 x 50m Libre

Cat. générale  
Liste résultats

Rang	Licence	T.I.	Temps final
------	---------	------	-------------

Championnat Belge Enseignement Universitaire et supérieur 2022  
Louvain-la-Neuve, 23-3-2022

Epreuve 21, Dames, 4 x 50m Libre

1.	KUL 1	BEL	KU LEUVEN	NT	<b>1:53.86</b>
	KENNIS, Nathalie		02	VANLOMMEL, Anke	00
	BROERE, Lieke		03	WATELLE, Anna	03
2.	UCL 1	BEL	UCL	NT	<b>1:58.58</b>
	DUMONT, Josephine		02	DUBOIS, Zoé	03
	DELMOTTE, Elodie		99	COETS, Shannon	01
3.	ERM 1	BEL	ERM	NT	<b>2:09.11</b>
	REMY-PAQUAY, Mazarine		02	PARENT, Elise	02
	MOMMEN, Inès		99	VABNDEMALELE, lucie	00
4.	UCL 2	BEL	UCL	NT	<b>2:09.55</b>
	BLOTHIAUX, Aline		01	ELIARD, Tania	02
	VAN LAEKEN, Laurayne		03	RONDEAU, Lola	03
5.	ULB 1	BEL	ULB	NT	<b>2:10.80</b>
	DELAHAUT, Romane		99	MAUXION, Pauline	03
	JANVIER, Zoé		00	MAHE, Louise	03
6.	ULB 2	BEL	ULB	NT	<b>2:17.16</b>
	DE ELIAS, Pilar		98	MAHE, Louise	03
	CLOUET, Anaïs		03	VILLERET, Sophie	02
7.	HEPL 1	BEL	HEPL	NT	<b>3:21.75</b>
	MALUENDA DRAPER, Catalina		99	JOHN-PIERRE, Apolline	03
	ABDALLAH, Virginie		02	DENIS, Lise	00
disq.	KUL 2	BEL	KU LEUVEN	NT	<b>2:10.45</b>
	<i>SW 10.11 - Départ anticipé du 2ème, 3ème ou 4ème nageur</i>				
	VERHENNE, Kaat		00	VAN DE VELPEN, Emma	00
	VANKEVELAER, nele		01	AMEYE, Jorijn	98

Epreuve 22  
23-03-22

Messieurs, 4 x 50m Libre

Cat. générale  
Liste résultats

Rang		Licence		T.I.	Temps final
1.	KUL 1	BEL	KU LEUVEN	NT	<b>1:41.16</b>
	SEMPELS, Gilles		02	LELIÈVRE-DAMIT, Jonas	97
	VERBEEK, Bram		99	CAMPS, Roeland	01
2.	UCL 1	BEL	UCL	NT	<b>1:43.36</b>
	MORIAU, Thibault		99	DEBONGNIE, Aymeric	99
	GREGOIRE, Juan		01	DENISON, Antoine	02
3.	ULB 1	BEL	ULB	NT	<b>1:43.87</b>
	DELHAYE, Bastien		02	DE ELÍAS, Alberto	92
	ROBIN, Thomas		00	HUBERTY, Mathieu	96
4.	ERM 1	BEL	ERM	NT	<b>1:46.41</b>
	BAECKELMANS, Jarne		00	DAENINCK, Kevin	
	PENNEMAN, Alexandre		01	DENOLF, Ward	02
5.	KUL T	BEL	KU LEUVEN T	NT	<b>1:46.85</b>
	SPRUYT, Linus		02	NIETO, Rodriguez	02
	CAMPS, Viktor		03	VAN BOGAERT, Bram	98
6.	ULB 2	BEL	ULB	NT	<b>1:49.26</b>
	JANSSENS, Florian		02	JEGO, Akira	96
	HOUTEVELT, Kyllian		02	FLAMAND, Timon	01
7.	UCL 2	BEL	UCL	NT	<b>1:50.52</b>
	BALHAUT, Augustin		03	VAN HAUWAERT, Joachim	02
	IBBERSON, William		03	LAROCHE, Florian	98

Championnat Belge Enseignement Universitaire et supérieur 2022  
Louvain-la-Neuve, 23-3-2022

Epreuve 22, Messieurs, 4 x 50m Libre, Cat. générale

Rang	Licence	T.I.	Temps final
8.	BEL KU LEUVEN	NT	<b>1:56.76</b>
	VERBEEK, Mats 01	HEYMANS, Quinten 03	
	HOLLEVOET, Robbe 02	ÖZGENER, Öke 02	
9.	BEL HEPL	NT	<b>2:03.44</b>
	POIRAUD, Ellie 02	PIERARD, Geoffrey 98	
	RICKER, Adrien 00	AERTS-BANCKEN, Guillaume 96	
forf.nd.	BEL HEPHC	NT	

Epreuve 23  
23-03-22

Mixte, 10 x 50m Libre

Cat. générale  
Liste résultats

Rang	Licence	T.I.	Temps final
1.	BEL KU LEUVEN	NT	<b>4:24.88</b>
	VANLOMMEL, Anke 00	KENNIS, Nathalie 02	
	WATELLE, Anna 03	VAN DER DONCKT, Steffen 98	
	VERBEEK, Bram 99	VANDERHULST, Tobe 03	
	LELIÈVRE-DAMIT, Jonas 97	CAMPS, Roeland 01	
	HOLLEVOET, Robbe 02	SEMPELS, Gilles 02	
2.	BEL UCL	NT	<b>4:33.65</b>
	MORIAU, Thibault 99	DELMOTTE, Elodie 99	
	GREGOIRE, Juan 01	IBBERSON, William 03	
	LAROCHE, Florian 98	COETS, Shannon 01	
	DUMONT, Josephine 02	DEBONGNIE, Aymeric 99	
	BALHAUT, Augustin 03	DENISON, Antoine 02	
3.	BEL HEPL	NT	<b>4:47.25</b>
	PIERARD, Geoffrey 98	GARCIA ZAMORA, Ilona 03	
	POIRAUD, Ellie 02	LAVENS, Camille 99	
	STREPENNE, Elisa 00	BISENIUS, Ryan 00	
	FEUILLEN, David 99	FRIPPIAT, Lory 00	
	RICKER, Adrien 00	AERTS-BANCKEN, Guillaume 96	
4.	BEL ULB	NT	<b>4:48.19</b>
	DELHAYE, Bastien 02	HUBERTY, Mathieu 96	
	ROBIN, Thomas 00	MAUXION, Pauline 03	
	DELAHAUT, Romane 99	FLAMAND, Timon 01	
	DE ELÍAS, Alberto 92	HOUTVELT, Kyllian 02	
	JANVIER, Zoé 00	JANSSENS, Florian 02	
5.	BEL UCL	NT	<b>4:58.15</b>
	VAN HAUWAERT, Joachim 02	HOUSSIÈRE, Pierre 02	
	VERSTRAETE, Edouard 98	RONDEAU, Lola 03	
	DUBOIS, Zoé 03	D'HONT, Cyril 00	
	VAN EETVELT, Mattias 00	FONLUPT, Frederic 02	
	VAN LAEKEN, Lauryne 03	BAFFREY, Xavier 00	
6.	BEL ERM	NT	<b>4:59.13</b>
	BAECKELMANS, Jarne 00	DAENINCK, Kevin 00	
	PENNEMAN, Alexandre 01	VABNDEMALELE, lucie 02	
	MOMMEN, Inès 99	REMY-PAQUAY, Mazarine 02	
	PARENT, Elise 02	DE BEUCKELAER, 02	
	HOUVENAGHEL, Brecht 00	DENOLF, Ward 02	
7.	BEL KU LEUVEN	NT	<b>5:06.72</b>
	VERBEEK, Mats 01	BROERE, Lieke 03	
	VERHENNE, Kaat 00	GOFFARD, Eduardo 97	
	ÖZGENER, Öke 02	AMEYE, Jorijn 98	
	GIESBERTS, Mirte 03	VAN DE VELPEN, Emma 00	
	VANKEVELAER, nele 01	HEYMANS, Quinten 03	

Championnat Belge Enseignement Univ et sup

Toutes les épreuves

Messieurs, Cat. générale

1. UCL	UCL	204,00
2. KU LEUVEN	KU LEUVEN	151,00
3. ULB	ULB	119,00
4. HEPL	HEPL	72,00
5. KU LEUVEN T	KULEUVEN T	44,00
6. ERM	ERM	35,00
7. HEPHC	HEPHC	24,00
8. EPHEC	EPHEC	22,00
9. HOWEST	HOWEST	20,00
10. HE2B	HE2B	14,00
11. THOMAS MORE	THOMASMORE	3,00
UGENT	UGENT	3,00
13. UNAMUR	UNAMUR	2,00
HEVINCI	HEVINCI	2,00
15. BOUST	BOUST	-
RBP	RBP	-
ULG (LG)	ULG (LG)	-
HERS	HERS	-
JOD	JOD	-
CNBA	CNBA	-
ENLN	ENLN	-
CNT	CNT	-
BLAC	BLAC	-
HOGESCHOOL GENT	HOGESCH GE	-

Dames, Cat. générale

1. UCL	UCL	246,00
2. KU LEUVEN	KU LEUVEN	167,00
3. HEPL	HEPL	94,00
4. ULB	ULB	54,00
5. ERM	ERM	47,00
6. ULG (LG)	ULG (LG)	16,00
7. HOGESCHOOL GENT	HOGESCH GE	11,00
8. HEPHC	HEPHC	-
HE2B	HE2B	-
UGENT	UGENT	-
BOUST	BOUST	-
RBP	RBP	-
EPHEC	EPHEC	-
HERS	HERS	-
HEVINCI	HEVINCI	-
UNAMUR	UNAMUR	-
JOD	JOD	-
CNBA	CNBA	-
ENLN	ENLN	-
CNT	CNT	-
BLAC	BLAC	-
KU LEUVEN T	KULEUVEN T	-
THOMAS MORE	THOMASMORE	-
HOWEST	HOWEST	-



Championnat Belge Enseignement Universitaire et supérieur 2022  
Louvain-la-Neuve, 23-3-2022

---

Tous, Cat. générale

1. UCL	UCL	482,00
2. KU LEUVEN	KU LEUVEN	350,00
3. ULB	ULB	187,00
4. HEPL	HEPL	182,00
5. ERM	ERM	92,00
6. KU LEUVEN T	KULEUVEN T	44,00
7. HEPHC	HEPHC	24,00
8. EPHEC	EPHEC	22,00
9. HOWEST	HOWEST	20,00
10. ULG (LG)	ULG (LG)	16,00
11. HE2B	HE2B	14,00
12. HOGESCHOOL GENT	HOGESCH GE	11,00
13. THOMAS MORE	THOMASMORE	3,00
UGENT	UGENT	3,00
15. UNAMUR	UNAMUR	2,00
HEVINCI	HEVINCI	2,00
17. BOUST	BOUST	-
RBP	RBP	-
HERS	HERS	-
JOD	JOD	-
CNBA	CNBA	-
ENLN	ENLN	-
CNT	CNT	-
BLAC	BLAC	-

# Résultats du Championnat FSUB de Padel

## Padel 4U2 à Gent

### Vendredi 22 avril 2022



RESULTATEN BSK PADEL - 22 APRIL - GENT					
A	Dorian	Mlynarski	Matthieu	Lambert	HEPH-Condorcet - Haute Ecole Provinciale du Hainaut - Condorcet
B	Florent	Baguet	Adrien	Rogee	HEH - Haute Ecole en Hainaut
C	Duncan	Wolff	Mathieu	Halut	HENALLUX - Haute Ecole de Namur-Liège-Luxembourg
D	Simon	Van Mossevelde	De Roose	Maxime	Arteveldehogeschool
E	Miel	Sweerman	De Smedt	Louie	Hogeschool Gent



Terrein 1	Uitslag	Terrein 2	Uitslag
B - E	2-9	C - D	0-9
E - C	9-2	A - B	9-1
C - A	0-9	D - E	9-6
D - B	9-2	E - A	1-9
A - D	6-9	B - C	9-3



	A	B	C	D	E	TOTAAL
A			3	3	0	3
B	0			3	0	0
C	0	0			0	0
D	3	3	3			3
E	0	3	3	3		6



1ste plaats	Simon + Maxime	Artevelde
2de plaats	Dorian + Matthieu	Condorcet
3de plaats	Miel + Louie	HoGent
4de plaats	Florent + Adrien	HEH
5de plaats	Duncan + Mathieu	Henallux

# CHAMPIONNAT FSUB Rugby VII : 09.03.22 VUB

HOMMES			DAMES		
Institutions	Points	GA	Institutions	Points	GA
EPHEC	0	-175	UCLouvain Wolves	12	83
HEVinci	12	56	HEVinci / ECAM	4	-16
UCLouvain Wolves	6	72	KULeuven	1	-67
Ass. KULeuven	6	47			



## Terrain 1

	Heure	Poule	Domicile	Score		Extérieur
M1	13h00	Dames	UCLouvain Wolves	17	10	HEVINCI/ ECAM
M2	13h20	Hommes	EPHEC	35	50	HEVINCI
M3	13h40	Hommes	UCLouvain Wolves	12	19	Ass. KULeuven
	14h00	Break				
M4	14h20	Dames	HEVINCI/ ECAM	15	10	KULeuven
M5	14h40	Hommes	EPHEC	0	67	UCLouvain Wolves
M6	15h00	Hommes	HEVinci	15	12	Ass. KULeuven
	15h20	Break				
M7	15h40	Dames	UCLouvain Wolves	20	10	KULeuven
M8	16h00	Hommes	EPHEC	0	55	Ass. KULeuven
M9	16h20	Hommes	HEVinci	33	7	UCLouvain Wolves
	16h40	Break				
M10	17h00	Dames	UCLouvain Wolves	19	5	HEVINCI/ ECAM
M11 - Finale	17h20	Hommes	HEVINCI	17	5	Ass. KULeuven
M12	17h40	Dames	UCLouvain Wolves	52	0	KULeuven
M13- Petit finale	18h00	Hommes	UCLouvain Wolves	38	0	EPHEC
M14	18h20	Dames	HEVINCI/ ECAM	10	10	KULeuven



Classement Hommes
HEVinci
Ass. KULeuven
UCLouvain Wolves
EPHEC

Classement Dames	
1	UCLouvain Wolves
2	HEVinci / ECAM
3	KULeuven

## TOURNOI FSUB Rugby VII : 28-10-21 au Kituro

HOMMES			DAMES		
Institutions	Points	GA	Institutions	Points	GA
HEVinci	15	+132	KU Leuven 1	3	-74
UCLouvain Wolves	12	+98	UCLouvain Wolves	12	186
HEPL	6	-24	KU Leuven 2	0	-115
HELB	0	-72			
ULB Owls	9	-13			
KU Leuven	3	-117			



### Terrain 1

	Heure	Poule	Domicile	Score		Extérieur	Arbitre
M1	12h00	Hommes	HEVinci	24	10	UCLouvain Wolves	G.E
M2	12h20	Hommes	HEPL	14	5	HELB	N.V
	12h40	Break					
M5	13h00	Hommes	HELB	0	38	HEVINCI	V.T
M6	13h20	Hommes	UCLouvain Wolves	21	7	ULB Owls	N.V
	13h40	Break					
M9	14h00	Hommes	UCLouvain Wolves	45	0	HELB	G.E
M10	14h20	Hommes	HEVinci	47	0	KU Leuven	V.T
	14h40	Break					
M13	15h00	Hommes	UCLouvain Wolves	35	5	KU Leuven	G.E
M14	15h20	Hommes	HELB	7	24	ULBowls	N.V
	15h40	Break					
M17	16h00	Hommes	HELB	19	22	KU Leuven	V.T
M18	16h20	Hommes	HEVinci	38	12	ULB Owls	G.E

### Terrain 2

	Heure	Poule	Domicile	Score		Extérieur	Arbitre
M3	12h00	Hommes	ULB Owls	7	0	KU Leuven	N.V
M4	12h20	Dames	KU Leuven 1	0	61	UCLouvain Wolves	V.T
	12h40	Break					
M7	13h00	Hommes	HEPL	36	0	KU Leuven	G.E
M8	13h20	Dames	KU Leuven 2	0	43	UCLouvain Wolves	V.T
	13h40	Break					
M11	14h00	Hommes	HEPL	14	17	ULB Owls	N.V
M12	14h20	Dames	KU Leuven 1	27	5	KU Leuven 2	G.E
	14h40	Break					
M15	15h00	Hommes	HEVinci	12	5	HEPL	N.V
M16	15h20	Dames	UCLouvain Wolves	32	7	KU Leuven 1	V.T
	15h40	Break					
M19	16h00	Hommes	UCLouvain Wolves	33	10	HEPL	N.V
M20	16h20	Dames	KU Leuven 2	0	50	UCLouvain Wolves	V.T

### Classement Hommes

- 1 HEVinci
- 2 UCLouvain Wolves
- 3 ULBowls
- 4 HEPL
- 5 KU Leuven
- 6 HELB

### Classement Dames

- 1 UCLouvain Wolves
- 2 KU Leuven1
- 3 KU Leuven 2

### Abréviat\*

Abréviat*	Arbitres
G.E	Grutadauria Enzo
V.N	Vervier Nicolas
V.T	Verbeek Thomas

### Calcul Classement

- 1) Points
- 2) Cartes rouges
- 3) Goal Average
- 4) Cartes jaunes
- 5) Tirage au sort

Résultats du Championnat FSUB  
de Tennis de Table  
Arteveldehogeschool/Studentensport  
Vlaanderen

Jeudi 24 février 2022



**a: artevelde**  
hogeschool

**Uitslag Tafeltennis B.U.S.F.-F.S.U.B. Kampioenschap.**  
**Sportcampus Arteveldehogeschool 20/02/2020**

**Reeks :**

- 1 Hoez Baptiste
- 2 Devue Wouter
- 3 Stanescu Gabriel
- 4 De Clercq Tom
- 5 Ketele Amaury
- 6 Heremans Senne
- 7 Hsieh Ping-Yi
- 8 Guo Xin
- 9 Reniers Mathieu
- 10 Carpentier Colin
- 11 Alexandre-Martin Samuel
- 12 Baurire Thomas
- 13 Gilson Jan
- 14 Stanescu Dan
- 15 Foguene Emile
- 16 Hanssens Tom
- 17 Van Belle Nils
- 18 Minette Benjamin
- 19 Jursch Natanaël
- 20 Kemp Quentin

**Heren**

- |    |                                  |
|----|----------------------------------|
| B2 | Université catholique de Louvain |
| B2 | KU Leuven                        |
| B0 | Université de Liège              |
| C0 | Odisee Hogeschool                |
| C0 | Université catholique de Louvain |
| B4 | Hogeschool West-Vlaanderen       |
| B6 | KU Leuven                        |
| C2 | Universiteit Gent                |
| C2 | Université catholique de Louvain |
| C0 | Université catholique de Louvain |
| C4 | Université catholique de Louvain |
| B6 | Université catholique de Louvain |
| C0 | KU Leuven                        |
| C0 | Université catholique de Louvain |
| C0 | Université catholique de Louvain |
| E6 | Université catholique de Louvain |
| E2 | KU Leuven                        |
| E0 | Université catholique de Louvain |
| D4 | KU Leuven                        |
| C2 | Université catholique de Louvain |

**Reeks :**

- 1 Tschirr Margaux
- 2 Evrard Gwendolyne
- 3 Eerdeken Hanne
- 4 Dufau Claire
- 5 Hendriks May-Ji

**Dames**

- |    |                                  |
|----|----------------------------------|
| B2 | Université de Namur              |
| C0 | Université catholique de Louvain |
| B4 | KU Leuven                        |
| B6 | Université catholique de Louvain |
| C6 | KU Leuven                        |

**Reeks :**

- 1 Kapoor Vasu
- 2 Fang Zhanfeng
- 3 Zhao Zixin
- 4 Shami Muhammad Usman
- 5 Hubin Robbe
- 6 De Cleyn Quinten
- 7 Anthony Onovo
- 8 Corijn Sam
- 9 de Keyser Flore

**Recreanten- Heren**

- |                                       |
|---------------------------------------|
| KU Leuven                             |
| KU Leuven                             |
| KU Leuven                             |
| KU Leuven - Campus Brussel            |
| LUCA                                  |
| Artesis Plantijn Hogeschool Antwerpen |
| Universiteit Hasselt                  |
| LUCA                                  |
| Universiteit Antwerpen                |

**Reeks :**

- 1 Zhao Zixin
- 2 de Keyser Flore

**Recreanten- Dames**

- |                        |
|------------------------|
| KU Leuven              |
| Universiteit Antwerpen |

Tafeltennis B.U.S.F.-F.S.U.B. kampioenschap 24/02/2022

Reeks : Dames

Poule : A

	NAAM	1	2	3	4	5	Match	Sets	Pl.
1	Tschirr Margaux B2 Unamur		3/1	3/0	3/0	3/1	4/0		1
2	Eerdekens Hanne B4 KU Leuven	1/3		3/0	2/3	3/1	2/2		3
3	Dufau Claire B6 UCL Wolves	0/3	0/3		0/3	3/1	1/3		4
4	Evrard Gwendolyn C0 UCL Wolves	0/3	3/2	3/0		3/0	3/1		2
5	Hendriks May-Ji C6 KU Leuven	1/3	1/3	1/3	0/3		0/4		5

Wedstr.	S	1	2	3	4	5	Sets
2--5	4	9/11	11/8	11/5	11/7		3/1
1--4	3	11/7	11/6	11/7			3/0
3--5	2	11/13	11/8	11/5	11/8		3/1
2--4	1	10/12	8/11	11/4	12/10	7/11	2/3
1--3	5	17/15	12/10	11/6			3/0
4--5	2	11/4	11/9	13/11			3/0
2--3	1	11/5	11/2	11/7			3/0
1--5	4	11/9	7/11	12/10	11/8		3/1
3--4	5	11/13	10/12	8/11			0/3
1--2	3	13/11	11/8	6/11	11/9		3/1



Tafeltennis B.U.S.F.-F.S.U.B. kampioenschap 24/02/2022

Reeks : Heren/Hommes

Poule : A

	NAAM	1	2	3	4	5	Match	Sets	Pl.
1	Stanescu Gabriel B0 ULiège		3/1	3/1	3/2	3/0	4/0		1
2	Foguenne Emile C0 UCL Wolves	1/3		1/3	3/2	1/3	1/3	4/5	4
3	Ketele Amaury C0 UCL Wolves	1/3	1/3		3/0	3/0	2/2		2
4	Alexandre-Martin Samuel C4 UCL Wolves	2/3	2/3	0/3		3/0	1/3	5/3	3
5	Jursch Natanaël D4 KU Leuven	0/3	3/1	0/3	0/3		1/3	3/4	5

Wedstr.	S	1	2	3	4	5	Sets
2--5	4	11/7	6/11	8/11	10/12		1/3
1--4	3	11/7	7/11	11/9	9/11	11/8	3/2
3--5	2	11/6	11/4	11/8			3/0
2--4	1	11/8	8/11	13/11	8/11	11/5	3/2
1--3	5	11/6	9/11	11/7	11/6		3/1
4--5	2	14/12	11/9	11/9			3/0
2--3	1	14/12	7/11	6/11	4/11		1/3
1--5	4	13/11	11/8	13/11			3/0
3--4	5	11/2	11/8	11/7			3/0
1--2	3	11/8	9/11	11/9	11/9		3/1

Reeks : Heren/Hommes

Poule : B

	NAAM	1	2	3	4	5	Match	Sets	Pl.
1	Devue Wouter B2 KU Leuven		3/0	3/1	1/3	3/0	3/1	10/4	2
2	Carpentier Colin C0 UCL Wolves	0/3		3/1	2/3	3/0	2/2	8/7	3
3	Stanescu Dan C0 UCL Wolves	1/3	1/3		0/3	3/2	1/3	5/11	4
4	Guo Xin C2 UGent	3/1	3/2	3/0		3/0	4/0	12/3	1
5	Minette Benjamin E0 UCL Wolves	0/3	0/3	2/3	0/3		0/4	2/12	5

Wedstr.	S	1	2	3	4	5	Sets
2--5	4	11/9	11/7	11/8			3/0
1--4	3	4/11	10/12	11/6	7/11		1/3
3--5	2	9/11	11/7	11/6	8/11	11/8	3/2
2--4	1	11/5	12/10	5/11	8/11	8/11	2/3
1--3	5	11/4	11/9	7/11	11/4		3/1
4--5	2	11/7	11/9	11/9			3/0
2--3	1	9/11	11/8	11/8	11/8		3/1
1--5	4	11/8	14/12	11/9			3/0
3--4	5	5/11	10/12	8/11			0/3
1--2	3	11/9	11/9	11/7			3/0

Tafeltennis B.U.S.F.-F.S.U.B. kampioenschap 24/02/2022

Reeks : Heren/Hommes

Poule : C

	NAAM	1	2	3	4	5	6	Match	Sets	Pl.
1	Hoez Baptiste B2 UCL Wolves		3/0	3/0	3/0	3/1	0	4/0	12/1	1
2	Hsieh Ping-Yi B6 KU Leuven	0/3		3/0	3/2	3/1	0	3/1	9/6	2
3	Gilson Jan C0 ULiège	0/3	0/3		1/3	3/1	0	1/3	4/10	4
4	Reniers Mathieu C2 UCL Wolves	0/3	2/3	3/1		3/0	0	2/2	8/7	3
5	Van Belle Nils E2 KU Leuven	1/3	1/3	1/3	0/3		0	0/4	3/12	5
6	0									

Wedstr.	S	1	2	3	4	5	Sets
1--6	3						
2--5	4	7/11	12/10	11/8	11/8		3/1
3--4	6	11/6	3/11	9/11	6/11		1/3
1--5	2	12/10	4/11	12/10	11/8		3/1
4--6	5						
2--3	1	11/8	12/10	11/7			3/0
1--4	2	12/10	11/7	13/11			3/0
3--5	6	12/10	13/11	3/11	11/7		3/1
2--6	4						
1--3	5	11/9	11/6	11/8			3/0
2--4	1	9/11	11/4	14/12	4/11	11/6	3/2
5--6	3						
1--2	4	11/4	11/1	11/6			3/0
3--6	5						
4--5	1	11/9	11/8	13/11			3/0

Reeks : Heren/Hommes

Poule : D

	NAAM	1	2	3	4	5	6	Match	Sets	Pl.
1	Heremans Senne B4 Hogeschool W-VL.		3/2	3/1	3/0	3/0	0	4/0	12/3	1
2	Baurire Thomas B6 UCL Wolves	2/3		1/3	3/1	3/1	0	2/2	9/8	3
3	De Clercq Tom C0 Odisee	1/3	3/1		1/3	3/1	0	2/2	8/8	2
4	Kemp Quentin C2 UCL Wolves	0/3	1/3	3/1		1/3	0	1/3	5/10	5
5	Hanssens Tom E6 UCL Wolves	0/3	1/3	1/3	3/1		0	1/3	5/10	4
6	0									

Wedstr.	S	1	2	3	4	5	Sets
1--6	3						
2--5	4	5/11	11/9	11/7	12/10		3/1
3--4	6	6/11	12/10	11/13	12/14		1/3
1--5	2	11/9	12/10	11/9			3/0
4--6	5						
2--3	1	8/11	6/11	11/7	7/11		1/3
1--4	2	11/8	11/8	11/8			3/0
3--5	6	12/10	3/11	12/10	12/10		3/1
2--6	4						
1--3	5	12/10	11/6	9/11	11/9		3/1
2--4	1	11/6	11/6	10/12	16/14		3/1
5--6	3						
1--2	4	9/11	11/6	9/11	11/9	11/4	3/2
3--6	5						
4--5	1	11/6	5/11	10/12	8/11		1/3

**REEKS : Heren / Hommes****START : 17h30****Tafeltennis B.U.S.F.-F.S.U.B. kampioenschap 24/02/2022**

1 Stanescu Gabriel B0 ULiège					
	Stanescu Gabriel B0 Uliège				
8 Hsieh Ping-Yi B6 KU Leuven	11/9 11/4 11/9				
		Devue Wouter B2 KU Leuven			
5 Devue Wouter B2 KU Leuven		11/13 11/13 9/11			
	Devue Wouter B2 KU Leuven				
4 Heremans Senne B4 Hogeschool W-VL.	10/12 11/9 11/6 11/9				
			Hoez Baptiste B2 UCL Wolves		
3 Hoez Baptiste B2 UCL Wolves			9/11 11/9 10/12 8/11		
	Hoez Baptiste B2 UCL Wolves				
6 Ketele Amaury C0 UCL Wolves	11/7 5/11 11/8 11/6				
		Hoez Baptiste B2 UCL Wolves			
7 De Clercq Tom C0 Odisee		11/8 8/11 11/5 11/6			
	De Clercq Tom C0 Odisee				
2 Guo Xin C2 UGent	12/10 4/11 11/6 11/7				

Tafeltennis B.U.S.F.-F.S.U.B. kampioenschap 24/02/2022

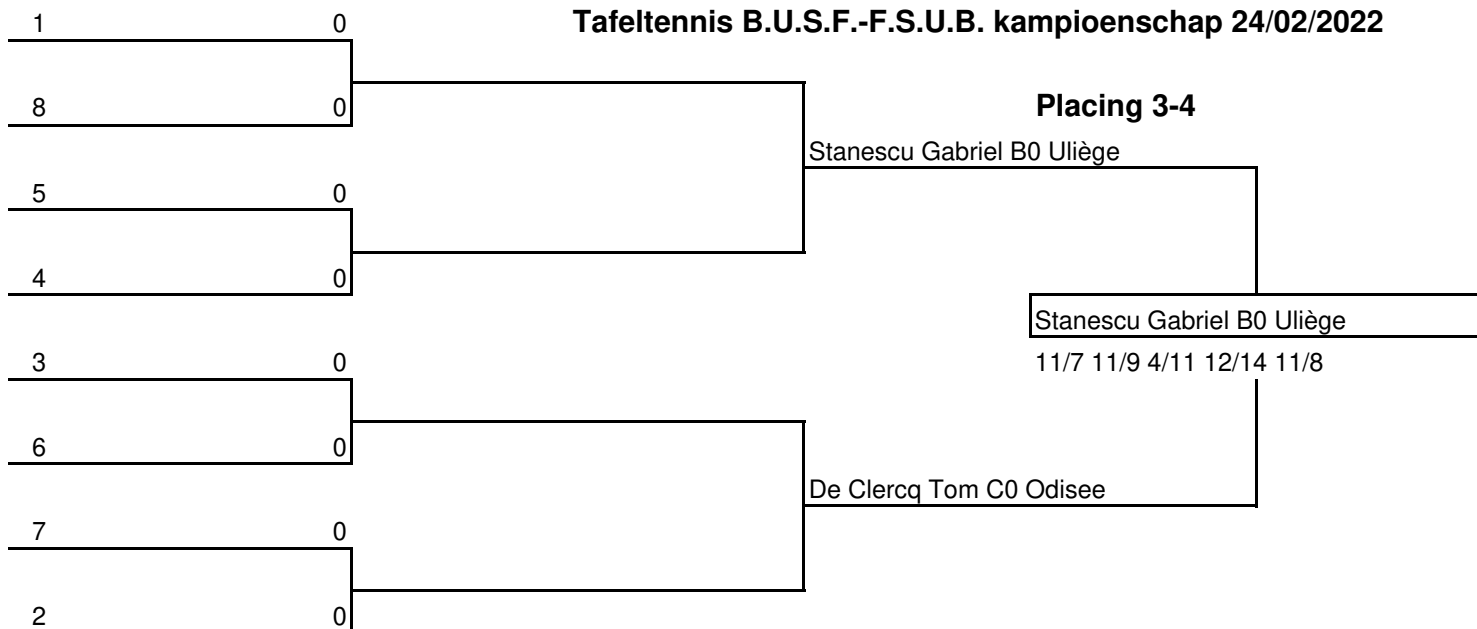

Placing 3-4

Stanescu Gabriel B0 Uliège

Stanescu Gabriel B0 Uliège

11/7 11/9 4/11 12/14 11/8

De Clercq Tom C0 Odisee

Tafeltennis B.U.S.F.-F.S.U.B. kampioenschap 24/02/2022

Reeks : Recreant

Poule : A

	NAAM	1	2	3	4	5	6	Match	Sets	Pl.
1	de Keyser Flore U Antwerpen		0	0/3	0/3	1/3	0/3	0/4	1/12	5
2	Agnieska Urbanek Karel De Grote			0	0	0	0			
3	Kapoor Vasu KU Leuven	3/0			3/0	3/0	3/0	4/0	12/0	1
4	Zhao Zixin KU Leuven	3/0		0/3		3/0	3/0	3/1	9/3	2
5	Hubin Robbe LUCA	3/1		0/3	0/3		0/3	1/3	3/10	3
6	Anthony Onovo Uhasselt	3/0		0/3	0/3	3/0		2/2	6/6	4

Wedstr.	S	1	2	3	4	5	Sets
1--6	3	2-11	3-11	2-11			0/3
2--5	4						
3--4	6	11/8	11/9	11/6			3/0
1--5	2	10/12	11/8	6/11	10/12		1/3
4--6	5	11/9	13/11	11/9			3/0
2--3	1						
1--4	2	2/11	1/11	3/11			0/3
3--5	6	11/5	11/4	11/4			3/0
2--6	4						
1--3	5	1/11	1/11	3/11			0/3
2--4	1						
5--6	3	2/11	4/11	2/11			0/3
1--2	4						
3--6	5	11/9	11/5	11/6			3/0
4--5	1	11/2	11/2	11/0			3/0

**REEKS : Recreant**

**Tafeltennis B.U.S.F.-F.S.U.B. kampioenschap 24/02/2022**

**START : 16h30**

1 Kapoor Vasu KU Leuven

11/3 11/8 8/11 11/8 Kapoor Vasu KU Leuven

4 Shami Muhammad Usman KUL-BXL

7/11 11/0 11/9 11/5 Kapoor Vasu KU Leuven

3 Zhao Zixin KU Leuven

11/6 11/9 9/11 5/11 5/11 Fang Zhanfeng KU Leuven

2 Fang Zhanfeng KU Leuven



REEKS : Recreant

Tafeltennis B.U.S.F.-F.S.U.B. kampioenschap 24/02/2022  
Placing 3-4

1	0	Shami Muhammad Usman KUL-BXL	14/12	5/11	6/11	8/11	Zhao Zixin KU Leuven
4	0						
3	0	Zhao Zixin KU Leuven	14/12	5/11	6/11	8/11	Zhao Zixin KU Leuven
2	0						

# Résultats du Championnat FSUB de Triathlon

Seneffe

Dimanche 15 mai 2022





## Résultats du championnat FSUB de Triathlon 15 mai 2022 à Seneffe



Class.	Class. Unif	Dossard	Nom Prénom	Sexe	Universitaires	Club	Natation	T1	Vélo	T2	Course	Arrivée
1.		155	VANHALST, Thomas	M		TRIGT	19:34	02:51	58:18	02:28	34:04	<b>1:57:15</b>
2.	1	16	SIMONS, Wouter	M	Hogeschool PXL	3PT	19:50	03:07	1:00:13	02:17	33:22	<b>1:58:49</b>
3.	2	2	VAELEN, Tom	M	ULiège (Liège)	TriGS	19:09	03:06	58:40	02:27	35:50	<b>1:59:12</b>
4.		153	LIBOIS, Joachim	M		TRIGT	19:36	02:56	1:00:41	02:23	34:34	<b>2:00:10</b>
5.		195	PHILIPPE, Olivier	M			21:23	02:59	1:01:58	02:33	34:12	<b>2:03:05</b>
6.		151	ROLIN, Boris	M		Trigt	21:17	03:17	1:01:03	02:43	35:44	<b>2:04:04</b>
7.		85	SIMONET, Yves	M		P8	21:26	03:20	1:03:50	02:38	35:33	<b>2:06:47</b>
8.		171	COUPE, Thomas	M		Turbo	19:30	03:19	1:03:09	03:12	37:50	<b>2:07:00</b>
9.		30	GILLAIN, Michael	M		Atcc	21:21	03:05	1:02:56	02:34	37:57	<b>2:07:53</b>
10.		207	CARUSO, Matheo	M			21:25	03:26	1:02:37	02:43	38:51	<b>2:09:02</b>
11.		142	WILLEMART, François	M		Tri-B	20:30	03:23	1:03:35	02:38	39:52	<b>2:09:58</b>
12.	3	23	DEMAZY, Guillaume	M	UCLouvain Wolves	3T	21:18	03:29	1:03:59	02:58	38:58	<b>2:10:42</b>
13.		160	CALIN, Thomas	M		TTDA	22:56	04:55	1:01:56	02:52	38:28	<b>2:11:07</b>
14.	4	129	GRIFGNÉE, Guillaume	M	HEPL	TDCH	20:32	03:22	1:03:52	02:45	40:58	<b>2:11:29</b>
15.		80	ADANT, Olivier	M		Nstt	22:51	03:16	1:05:41	02:41	37:15	<b>2:11:44</b>
16.		133	FRIPPIAT, Jean	M		Tri4phil	24:41	03:17	1:03:26	02:57	38:16	<b>2:12:37</b>
17.		61	LEROY, Remy	M		ETM	23:06	03:48	1:04:08	02:55	39:36	<b>2:13:33</b>
18.		59	GRIMONPREZ, Julien	M		Etm	24:11	04:03	1:03:31	03:17	38:43	<b>2:13:45</b>
19.	5	156	GOUEMANT, Tom	M	UCLouvain Wolves	TriGT	21:21	03:27	1:04:39	02:51	41:45	<b>2:14:03</b>
20.	6	128	GRIFGNEE, Maxime	M	HELMo	TDCH	21:17	03:33	1:03:49	02:49	42:42	<b>2:14:10</b>
21.	7	34	BERTHOLOMÉ, Arthur	M	HELMo	AUCUN	21:26	04:08	1:06:15	02:45	40:00	<b>2:14:34</b>
22.		88	BLANCHARD, Victor	M		Racing Club Bruxelles Triathlon	23:21	03:34	1:05:45	02:45	39:10	<b>2:14:35</b>
23.		166	VANBELLAINGH, Julien	M		TTR / TRAKKS	20:03	04:30	1:08:50	03:01	38:17	<b>2:14:41</b>
24.		62	MEEUS, Nik	M		GETC	24:15	03:54	1:04:19	03:07	39:11	<b>2:14:46</b>
25.		117	ARNOULD, Anton	M		STT	24:31	04:14	1:06:30	03:04	38:00	<b>2:16:19</b>
26.		6	HEYRMAN, Jonathan	M		rcbt	21:14	03:26	1:06:05	02:41	43:26	<b>2:16:52</b>
27.		103	BOUILLET, Louis	M		RCBT	21:18	03:24	1:06:03	02:40	43:42	<b>2:17:07</b>
28.		130	VANSTEENLAND, Brice	M		TPA	27:10	03:40	1:03:18	03:11	40:11	<b>2:17:30</b>
29.		197	LIAHUSHYN, Pavlo	M			21:23	03:55	1:06:31	03:02	42:53	<b>2:17:44</b>
30.	8	180	BLAIRVACQ, Simon	M	UCLouvain Wolves	WATTS	24:29	04:11	1:07:09	02:49	39:16	<b>2:17:54</b>
31.		102	GHOMRAOUI, Bilal	M		RCBT	22:08	03:34	1:06:01	02:51	43:37	<b>2:18:11</b>
32.		124	EGGERICKX, Pierre	M		TCDM	24:20	03:32	1:03:33	02:45	44:43	<b>2:18:53</b>
33.	1	3	CLAISSE, Emma	F	UCLouvain Wolves	TRIGT	23:51	03:20	1:07:10	02:51	42:07	<b>2:19:19</b>
34.		40	ROMAGUERA BOSCH, Jordi	M		BTC	23:19	03:28	1:07:35	02:37	42:23	<b>2:19:22</b>
35.		21	IGLESIAS, Nicolas	M		3t	24:34	03:30	1:06:51	03:13	42:22	<b>2:20:30</b>



## Résultats du championnat FSUB de Triathlon 15 mai 2022 à Seneffe



36.		44	LARONDELLE, Gaetan	M		BTC	24:41	04:09	1:08:26	02:46	40:31	<b>2:20:33</b>
37.		179	VICKEVORST, Geoffrey	M		VitaliTri	23:16	03:48	1:07:12	03:16	43:23	<b>2:20:55</b>
38.		14	VANCOLEN, Pierre	M		/	25:05	03:52	1:10:42	03:47	37:33	<b>2:20:59</b>
39.		105	BACQ, Pierre-Loïc	M		RCBT	23:50	04:52	1:06:44	03:20	42:29	<b>2:21:15</b>
40.		7	DANS, Pierre	M		TRITR	24:01	04:48	1:08:26	03:28	40:47	<b>2:21:30</b>
41.	9	126	HENAUT, Louis	M	HE2B	TCDM	24:15	04:03	1:02:44	03:05	47:46	<b>2:21:53</b>
42.		199	GUEUNING, Louis	M			21:58	04:21	1:05:21	03:58	47:09	<b>2:22:47</b>
43.		64	CRUL, Timothy	M		GTC	25:29	04:57	1:09:59	02:56	39:49	<b>2:23:10</b>
44.		177	DE LOCHT, Maxence	M		V3	27:08	03:44	1:06:26	02:38	43:21	<b>2:23:17</b>
45.		74	RIVART, Christophe	M		Mytribe	25:27	04:54	1:05:45	04:01	43:54	<b>2:24:01</b>
46.		178	DEJONG, Daniel	M		VITALITRI	23:55	03:44	1:07:20	03:28	45:44	<b>2:24:11</b>
47.		144	DE BILDERLING, Nathan	M		tribikestation	29:15	05:11	1:07:16	03:36	39:25	<b>2:24:43</b>
48.	10	35	LECLERCQ, Rémi	M	HELHa	AUCUN	28:46	04:17	1:06:38	03:05	42:01	<b>2:24:47</b>
49.		96	NAVEZ, Julie	F		RCBT	25:09	04:23	1:09:41	03:04	43:35	<b>2:25:52</b>
50.		29	MINETTE, Sebastien	M		Atcc	21:32	04:13	1:09:49	03:21	47:31	<b>2:26:26</b>
51.		152	ROMMEL, Maëlyss	F		TRIGT	23:39	03:33	1:12:27	03:11	43:51	<b>2:26:41</b>
52.		56	BROICH, Markus	M		Erdinger	23:31	04:05	1:11:52	03:39	43:39	<b>2:26:46</b>
53.		186	CHATELUS, Sebastien	M			25:19	04:07	1:09:51	03:11	45:03	<b>2:27:31</b>
54.		71	MAHAUX, Philippe	M		Lstt	26:57	04:26	1:08:47	03:44	43:43	<b>2:27:37</b>
55.	11	4	SANZ, Leandro	M	ULiège (Liège)	VitaliTri	25:16	03:26	1:13:36	02:42	42:38	<b>2:27:38</b>
56.		46	ROBERT, Gauthier	M		BTC	26:35	04:34	1:08:48	03:25	44:50	<b>2:28:12</b>
57.		114	THEATE, Françoise	F		SG3A	22:28	04:07	1:13:17	03:20	45:25	<b>2:28:37</b>
58.		192	DESGAIN, Thomas	M			30:10	04:55	1:07:32	03:38	42:34	<b>2:28:49</b>
59.	12	116	BIERNAUX, Doriano	M	HE2B	SG3A	24:25	04:28	1:12:41	02:51	44:49	<b>2:29:14</b>
60.		68	HANOT, Anthony	M		Individuel	22:17	05:16	1:07:30	03:45	50:27	<b>2:29:15</b>
61.		147	MERCHIE, Frederic	M		TRIGT	25:23	04:14	1:09:41	03:24	47:29	<b>2:30:11</b>
62.		89	REMY, Sebastien**	M		RCBT	24:23	04:42	1:10:59	03:19	46:58	<b>2:30:21</b>
63.		41	ROBBERECHTS, Tom	M		BTC	27:08	04:40	1:10:04	03:33	45:03	<b>2:30:28</b>
64.		91	VAN MUYSEWINKEL, Cedric	M		RCBT	28:09	05:07	1:11:55	03:16	42:05	<b>2:30:32</b>
65.		120	STOQUART, Gauthier	M		TCA	29:06	04:05	1:11:27	03:00	43:23	<b>2:31:01</b>
66.		99	BILLIET, Anthony	M		RCBT	26:05	04:32	1:10:50	03:06	46:36	<b>2:31:09</b>
67.		33	AGORASTOS, Nicolas	M		Atcc charleroi	28:52	05:58	1:04:11	03:57	48:25	<b>2:31:23</b>
68.		18	COBUT, Etienne	M		3T	29:32	04:50	1:11:04	03:08	43:06	<b>2:31:40</b>
69.	2	51	MOMMEN, Inès	F	ERM	BTC	22:20	03:39	1:08:20	03:06	54:16	<b>2:31:41</b>
70.		187	PETIT, Sébastien**	M			23:18	04:19	1:09:03	04:10	50:53	<b>2:31:43</b>
71.		118	LALLEMAND, Thibaut	M		TCA	28:20	04:56	1:08:47	03:53	45:58	<b>2:31:54</b>
72.		110	HOUYOUX, Guillaume	M		RCBT	22:02	04:15	1:11:20	03:07	51:12	<b>2:31:56</b>



## Résultats du championnat FSUB de Triathlon 15 mai 2022 à Seneffe



73.		73	DEVENYNS, Stephane	M		Madres	28:45	04:46	1:11:14	02:59	44:16	<b>2:32:00</b>
74.		119	MAHEE, Céline	F		TCA	29:50	05:24	1:14:17	03:38	39:53	<b>2:33:02</b>
75.		27	LECAT, Nathalie	F		Atcc	31:49	05:03	1:11:52	03:31	41:48	<b>2:34:03</b>
76.	13	37	LEGROS, Victor	M	HEPH-Condorcet	BBRT	24:47	04:41	1:09:10	03:44	51:46	<b>2:34:08</b>
77.		60	VERCRUYSSSE, Thibaut	M		ETM	25:24	04:28	1:13:06	03:19	47:54	<b>2:34:11</b>
78.		106	RAMARD, Guillaume	M		RCBT	29:35	05:55	1:12:16	04:10	42:31	<b>2:34:27</b>
79.		132	QUINIET, Helene	F		TRAKKS	26:08	05:08	1:15:21	03:29	44:49	<b>2:34:55</b>
80.		58	WISEUR, Alexis	M		ETC	26:11	03:48	1:11:24	03:36	50:09	<b>2:35:08</b>
81.		137	PETRY, Alexandre	M		Triathlon Club Andenne	30:09	04:58	1:12:26	03:28	44:11	<b>2:35:12</b>
82.		203	GUEUNING, Colin	M			23:31	04:29	1:14:22	04:08	49:09	<b>2:35:39</b>
83.		204	LOUIS, Arthur	M			24:07	04:42	1:09:57	04:24	52:38	<b>2:35:48</b>
84.		48	POISMANS, René-Pascal	M		BTC	24:36	05:07	1:11:55	04:34	49:49	<b>2:36:01</b>
85.		134	GUIBERT, Christophe	M		Triathliege	24:36	04:44	1:15:56	03:54	46:56	<b>2:36:06</b>
86.		202	VAN DE CASTEELE, Alexandre	M			29:52	04:01	1:10:58	04:17	47:12	<b>2:36:20</b>
87.		45	DESMARETS, Thibaut	M		BTC	29:12	04:50	1:12:19	03:32	46:50	<b>2:36:43</b>
88.		198	VANTHOURNOUT, Brandon	M			25:12	04:46	1:12:10	03:50	50:50	<b>2:36:48</b>
89.		66	SIMILLION, Hans	M		H30	24:56	04:58	1:14:38	05:37	47:35	<b>2:37:44</b>
90.		165	MARCOUX, Benjamin	M		TTR	28:12	04:50	1:12:38	04:03	48:23	<b>2:38:06</b>
91.		108	HEYLBROECK, Kevin	M		RCBT	24:25	04:26	1:16:59	03:40	48:38	<b>2:38:08</b>
92.		43	LINA, Aurélien	M		BTC	23:40	05:09	1:16:00	03:16	50:30	<b>2:38:35</b>
93.		122	LOGNARD, Edwin	M		Tcbm	29:27	06:05	1:09:05	03:36	50:25	<b>2:38:38</b>
94.		100	LAMBERT, Agnes	F		RCBT	26:50	04:58	1:15:32	03:49	47:48	<b>2:38:57</b>
95.		78	RASSON, Nicolas*	M		NSTT	27:25	05:05	1:12:10	04:35	49:49	<b>2:39:04</b>
96.		161	CREMER, Céline	F		TTDA	25:43	05:02	1:12:17	03:53	52:43	<b>2:39:38</b>
97.		90	SCHOONJANS, Michel	M		RCBT	25:40	05:31	1:15:21	04:23	49:24	<b>2:40:19</b>
98.		158	LEMAIRE, Lionel	M		TRILGE	27:18	05:17	1:15:20	03:53	48:36	<b>2:40:24</b>
99.		188	MARCEL, Mathieu	M			26:00	04:58	1:18:31	03:40	47:30	<b>2:40:39</b>
100.		72	DESMET, Guillaume	M		LSTT	28:26	04:28	1:11:35	03:12	53:19	<b>2:41:00</b>
101.		19	THEYS, Thomas	M		3T	31:46	05:19	1:12:26	04:00	47:58	<b>2:41:29</b>
102.		101	BERSINI, Louis	M		RCBT	28:42	06:03	1:16:22	04:19	46:50	<b>2:42:16</b>
103.		86	CURELLA, Alessandro	M		Puissance huy'T	27:14	04:58	1:13:35	04:54	51:55	<b>2:42:36</b>
104.		38	VERHOEST, Peter	M		BLB	35:07	05:26	1:13:47	03:54	44:28	<b>2:42:42</b>
105.		49	BIHAIN, Alexandra	F		BTC	24:02	03:56	1:15:07	03:30	56:07	<b>2:42:42</b>
106.		47	SUYS, Olivier	M		BTC	29:35	04:30	1:10:36	03:06	55:26	<b>2:43:13</b>
107.		139	DIEU, Nicolas	M		Triathlon team Braine	30:12	04:32	1:12:46	03:54	51:55	<b>2:43:19</b>
108.		127	GRIFGNEE, Thierry	M		TDCH	28:24	04:29	1:14:14	04:09	52:56	<b>2:44:12</b>
109.		93	SCATLIFFE, Danitza	F		RCBT	25:40	06:29	1:14:01	04:40	53:23	<b>2:44:13</b>



## Résultats du championnat FSUB de Triathlon 15 mai 2022 à Seneffe



110.		17	ADANT, Jean	M		3T	32:48	06:39	1:13:04	03:50	49:02	<b>2:45:23</b>
111.		94	TESIC, Tatjana	F		RCBT	22:31	04:19	1:19:21	03:31	56:27	<b>2:46:09</b>
112.		206	NACHTERGAELE, Hugo	M			29:38	05:31	1:21:31	03:41	46:12	<b>2:46:33</b>
113.		121	MAURISSEN, Hervé	M		TCBM	25:44	05:11	1:11:14	04:58	1:00:01	<b>2:47:08</b>
114.		82	LAVAL, Bernard	M		P 8	29:25	06:03	1:15:16	04:21	52:05	<b>2:47:10</b>
115.		25	DI MARCOBERARDINO, Franco	M		ATCC	30:21	05:44	1:13:31	04:17	53:25	<b>2:47:18</b>
116.		135	RONDEUX, Jonathan	M		Triathliège	26:06	05:06	1:17:56	04:01	54:16	<b>2:47:25</b>
117.		172	MOREL, Martin	M		Uclouvain	27:26	06:11	1:18:59	04:24	50:32	<b>2:47:32</b>
118.		141	WERGIFOSSE, Thierry**	M		Tri-b	25:16	05:50	1:13:43	04:08	59:05	<b>2:48:02</b>
119.		190	VLEMINCKX, Jason	M			31:48	06:17	1:20:24	05:00	45:19	<b>2:48:48</b>
120.		191	BRUYNEEL, Arnaud**	M			29:28	06:15	1:19:28	05:07	49:09	<b>2:49:27</b>
121.		92	GAETE DEL RIO, Nicolas	M		RCBT	30:12	05:17	1:16:26	04:28	53:16	<b>2:49:39</b>
122.		8	KULESZA - WALCZAK, Wioletta	F		RCBT	27:20	04:50	1:16:27	04:12	57:36	<b>2:50:25</b>
123.		84	BEAUJEAN, Olivier*	M		P8	32:09	05:22	1:13:22	03:53	56:15	<b>2:51:01</b>
124.		5	HAMMENECKER, Jules	M		RCBT	31:47	05:05	1:18:42	03:40	51:51	<b>2:51:05</b>
125.		194	DEQUEVY, Sébastien	M			34:42	07:30	1:14:53	04:34	50:18	<b>2:51:57</b>
126.		79	PAIRON, Marie	F		NSTT	29:52	05:34	1:19:33	03:31	53:39	<b>2:52:09</b>
127.		26	VANDERSTRAETEN, Pierre	M		ATCC	28:48	06:33	1:11:15	05:26	1:00:32	<b>2:52:34</b>
128.		9	LAMEIR, Christian	M		RCBT	28:45	06:04	1:18:34	03:55	56:06	<b>2:53:24</b>
129.		176	BEUDIN, Audric	M		UTT	28:36	06:19	1:17:27	04:09	57:14	<b>2:53:45</b>
130.		173	LUNARDI, Antoine	M		UCLouvain	29:08	06:00	1:19:39	04:40	54:47	<b>2:54:14</b>
131.		189	MINGOIA, Jonathann	M			33:54	06:57	1:16:52	04:28	52:37	<b>2:54:48</b>
132.		22	COULON, Nathanael	M		3T	33:47	06:25	1:18:16	04:18	53:08	<b>2:55:54</b>
133.		182	DESOMBERG, Philippe	M			32:38	07:47	1:17:47	05:21	56:24	<b>2:59:57</b>
134.		146	PETIT, Thibault	M		Trifly	37:44	05:08	1:14:32	03:54	59:32	<b>3:00:50</b>
135.		83	KOHL, Angélique	F		P8	35:58	05:26	1:19:15	04:08	56:13	<b>3:01:00</b>
136.		77	BEAUDOT, Cedric	M		NSTT	28:13	04:42	1:16:27	04:45	1:09:33	<b>3:03:40</b>
137.	<b>3</b>	111	MOREAU, Marie	F	<b>VUB</b>	RCBT	27:22	04:26	1:24:02	04:26	1:04:22	<b>3:04:38</b>
138.		169	BEN MAIZ, Elyes	M		TURBO	37:58	05:32	1:20:30	04:11	56:44	<b>3:04:55</b>
139.		65	CALVAGNA, Franco	M		H30	33:09	07:23	1:18:34	05:19	1:00:55	<b>3:05:20</b>
140.		50	RONKART, Nathan	M		BTC	40:00	05:41	1:17:24	05:14	58:44	<b>3:07:03</b>
141.		15	HEYLEN, Thomas	M		/	27:51	05:43	1:24:52	04:09	1:05:12	<b>3:07:47</b>
142.		184	VERLINDEN, Nadia	F			34:02	07:13	1:27:07	05:26	54:15	<b>3:08:03</b>
143.		24	VANESSE, Myriam	F		ATCC	29:26	06:04	1:26:23	05:03	1:01:20	<b>3:08:16</b>
144.		125	TESTU, Henri	M		TCDM	29:48	05:46	1:22:52	03:57	1:06:46	<b>3:09:09</b>
145.		159	MATHELET, Lise	F		TTB	29:06	05:55	1:26:34	04:19	1:04:17	<b>3:10:11</b>
146.		157	SERON, Serge	M		TRILGE	26:53	08:04	1:20:48	06:11	1:08:37	<b>3:10:33</b>



## Résultats du championnat FSUB de Triathlon 15 mai 2022 à Seneffe



147.		95	HAYETTE, Christophe	M		RCBT	35:00	06:21	1:20:02	06:44	1:05:34	<b>3:13:41</b>
148.		28	BOSERET, Sébastien	M		ATCC	28:07	05:32	1:19:23	05:13	1:16:14	<b>3:14:29</b>
149.		32	LAGNEAU, Jean-Marie	M		ATCC	22:12	04:46	1:20:08	05:22	1:22:03	<b>3:14:31</b>
150.		70	HELAS, Jennyfer	F		LifeSport Tri Team	32:30	06:29	1:28:08	03:48	1:04:32	<b>3:15:27</b>
151.		205	TRAPPENIERS, Axel	M			29:54	04:34	1:16:35	03:36	1:27:12	<b>3:21:51</b>
152.		181	OPDEBEECK, Dominique	M			36:14	06:56	1:26:21	05:06	1:07:31	<b>3:22:08</b>
153.		193	NILLES, Marie	F			32:58	08:58	1:29:29	06:45	1:05:29	<b>3:23:39</b>
154.		123	LEGRAND, Lionel*	M		TCBM	37:22	06:47	1:26:19	05:29	1:08:21	<b>3:24:18</b>
155.		31	WERION, Delphine	F		ATCC	24:19	05:49	1:26:56	05:26	1:21:58	<b>3:24:28</b>
156.		185	MARTIN PEREZ, Idafe	M			31:55	08:43	1:26:45	05:38	1:16:17	<b>3:29:18</b>
157.		76	ORTIZ, Adrian	M		Neant	45:42	06:46	1:16:23	06:00	1:14:55	<b>3:29:46</b>
158.		112	PORIAU, Christine	F		RCNamur	39:10	09:21	1:51:58	07:45	1:09:33	<b>3:57:47</b>
159.		174	FERNANDEZ GARCIA, Jose	M		UTT	40:01	09:53	1:39:09	09:48	1:20:32	<b>3:59:23</b>
160.		11	PIGNARD, Eric	M		0	41:48	09:49	1:36:44	07:41	1:33:15	<b>4:09:17</b>
DNF	<b>14</b>	87	PATRICIO, Daniel	M	ULB Owls	Racing Club Bruxelles Triathlon	23:56	03:58	1:07:38	03:10		DNF
DNF		143	DE BILDERLING, Georges	M		Tribike	32:55	05:57	1:12:36	04:06		DNF



## Résultats des Finales FSUB GENT le 20 avril 2022

BASKET-BALL DAMES	SCORE	VAINQUEUR
UGENT – UCLouvain Wolves	65 - 63	UGENT
<b>BASKET-BALL HOMMES</b>		
Ass. KU Leuven – ULiège (Liège)	85 - 65	Ass. KU Leuven
<b>FOOTBALL</b>		
VUB – UCLouvain Wolves	2 - 1	VUB
<b>FUTSAL DAMES</b>		
KU Leuven - HEPL	4 - 3	KU Leuven
<b>FUTSAL HOMMES</b>		
HOGENT - HEPL	4 - 3	HOGENT
<b>HANDBALL HOMMES</b>		
KU Leuven - HEPL	23 - 36	HEPL
<b>HANDBALL DAMES</b>		
Ass. KU Leuven – UCLouvain Wolves	20 - 21	UCLouvain Wolves
<b>HOCKEY HOMMES</b>		
AUGENT- UCLouvain Wolves	3 (6) – 3 (8)	UCLouvain Wolves
<b>HOCKEY DAMES</b>		
UGent – ULB Owls	1 - 10	ULB Owls
<b>RUGBY XV</b>		
Ass. KU Leuven – HE Vinci	19 - 8	Ass. KU Leuven
<b>TENNIS DAMES</b>		
KU Leuven – HE Vinci	1 - 2	HE Vinci
<b>TENNIS HOMMES</b>		
AUGent – UCLouvain Wolves 1	2 - 4	UCLouvain Wolves 1
<b>VOLLEY- BALL DAMES</b>		
UGENT – UCLouvain Wolves	3 – 0 (25/18 – 25/21 – 25/22)	UGENT
<b>VOLLEY- BALL HOMMES</b>		
Ass. KU Leuven – UCLouvain Wolves	3 – 2 (19/25 - 25/18 - 25/17 - 22/25 - 15/10)	Ass. KU Leuven
<b>WATERPOLO</b>		
AUGENT – ULB Owls	19 - 8	AUGENT





# ESCALADE

## FSUBCHAMPIONSHIP

Championnat de Belgique de l'Enseignement  
Universitaire et Supérieur

### DATE

Lundi 25 avril 2022

# ANNULÉ

### LIEU

at Bleau Gent  
20, Zuiderlaan  
9000 Gent

### HEURES

Qualifications : 10H  
Finale : 14 H

Fin des inscriptions le 11 avril à 16H

**Tu veux t'inscrire à la compétition ?**

Scanne le QR Code et complète le formulaire !

**Plus d'infos**

[www.aseus.be](http://www.aseus.be)



En partenariat avec



B.U.S.F. - F.S.U.B.





# SQUASH

## FSUBCHAMPIONSHIP

Championnat de Belgique de l'Enseignement  
Universitaire et Supérieur

**DATE**

Mercredi 8 Décembre 2021

**ANNULÉ**

**HEURE**

De 16h à 20H

**INSCRIPTIONS**

Maximum 24 inscrits

Fin des inscriptions le 1er décembre

**COVID SAFE TICKET OBLIGATOIRE**

**Tu veux t'inscrire à la compétition ?**

Scanne le QR Code et complète le formulaire !

**Plus d'infos**

[www.aseus.be](http://www.aseus.be)



En partenariat avec



B.U.S.F. - F.S.U.B.





# ULTIMATE FRISBEE

## FSUBCHAMPIONSHIP

Championnats de Belgique de l'Enseignement  
Universitaire et Supérieur

### DATE

Samedi 23 avril 2022

Universitaire et Supérieur

# ANNULÉ

Université de la Région de Bruxelles-Capitale

Université de la Région de Bruxelles-Capitale

Université de la Région de Bruxelles-Capitale

Université de la Région de Bruxelles-Capitale

Université de la Région de Bruxelles-Capitale

### HEURE

Début des compétitions : 10H00

Horaire adapté selon le nombre  
d'inscriptions

Fin des inscriptions le lundi 18 avril

**Tu veux t'inscrire à la compétition ?**

Scanne le QR Code et complète le formulaire !

**Plus d'infos**

[www.aseus.be](http://www.aseus.be)



En partenariat avec

**KU LEUVEN**

**studentensport**  
Vlaanderen

**FÉDÉRATION**  
WALLONIE-BRUXELLES

**Adeps**  
FÉDÉRATION WALLONIE-BRUXELLES

**ASEUS**  
Association Sportive de l'Enseignement  
Universitaire et Supérieur

B.U.S.F. - F.S.U.B.

